

2023

# contract



**Siesta**  
exclusive



## Siesta exclusive

Siesta, established in 1987, offers to an international public satisfying the most varied needs, through products conceived in the name of functionality and design.

The continuous attention to the needs and tendencies of the market has led to a constant and balanced development throughout time, determining a first hand position for both productive capacity and also from a commercial point of view. This has been possible thanks to constant research on productive and technological aspects and also on the esthetics and on product promotion.

The freshness of the design of Siesta tables and chairs together with the competitive price satisfies different levels of needs. These characteristics give Siesta access to different market sectors, for example contract and domestic.

The collection includes chairs, bar stools and tables, all designed to be multifunctional and multi-purpose, user friendly and with an indisputable style. With their colour, sense of irony, play on senses and unique forms, Siesta products are immediately recognizable throughout the world, offering longlasting, practical enjoyment. Today Siesta exports 75% of its production to 80 countries around the globe through its comprehensive network of agents and dealers.

Siesta offers an extremely wide range of indoor and outdoor products, with innumerable colour variations, with plastic materials like polypropylene and fiberglass matched to wood or metal or latest trend like transparent polycarbonate or glossy PA6 nylon, with strong technical characteristics, that give the product inimitable qualities such as softness, opaqueness, flexibility and resistance to atmospheric agents.

A concentrate of quality that makes the Siesta product so unique and special.

































# CHECKLIST OF OBJECTS

CHAIRS & ARMCHAIRS					
		PARIS 10	HELEN 12	PACIFIC LOUNGE ARMCHAIR 14	PACIFIC LOUNGE CHAIR 16
					
VICTOR XL 30	CROSS 32	CROSS XL 34	MARCEL 36	MARCEL XL 38	DREAM 40
					
SUNSET 54	PLUS 56	SNOW 58	MOON 60	FLASH 62	BLOOM 64
					
OPERA 78	CHIAVARI 80	CRYSTAL 82	ELIZABETH 84	BABY ELIZABETH 86	ELIZABETH-C 88
					
ALLEGRA 102	ALLEGRA-PP 104	MIO-PP 106	MIO 108	MAYA 110	DIVA 112
					
TIFFANY-S 126	LUCCA 128	LUCCA-T 130	DOLCE 132	VITA 134	ROMEO 136

					
PACIFIC ARMCHAIR 18	SKY PRO 20	SKY 22	SKY LOUNGE 24	MARIE 26	VICTOR 28
					
MONNA 42	LISA 44	LUCY 46	LOFT 48	MILA 50	PIA 52
					
AIR XL 66	AIR 68	MIRANDA 70	SOHO 72	JOSEPHINE 74	NAPOLEON 76
					
ARTHUR 90	BO 92	BEE 94	MISS BIBI 96	MR BOBO 98	CARMEN 100
					
BOX 114	BOX SOFA 116	ARES 118	ARTEMIS 120	ARTEMIS XL 122	TIFFANY 124
					LOUNGE
JULIETTE 138	GALA 140	BELLA 142	ARTEMIS XL CUSHIONS 144	LINK LINKING DEVICE 146	

# CHECKLIST OF OBJECTS

					
PACIFIC LOUNGE SET WITH ARMS 150		PACIFIC LOUNGE SET WITHOUT ARMS 152		PACIFIC LOUNGE EXTENSION PART 154	
					
MYKONOS LOUNGE CORNER SET 168		MYKONOS LOUNGE ARMCHAIR 172	MYKONOS LOUNGE TABLE 174	MYKONOS LOUNGE TABLE XL 176	MYKONOS EXTENSION PART 178
			STOOLS & COMPLEMENTS ▶		
TROPIC ARM 186	PACIFIC 188	SLIM CUSHIONS 190			TOM 45 194
					
MARCEL BAR 75 208	MARCEL BAR 65 210	MAYA BAR 75 212	MAYA BAR 65 214	ARES BAR 75 216	OPERA BAR 75 218
					
AIR BAR 65 232	ARIA 234	GIO 75 236	QUEEN 238	SKY SIDE TABLE 240	SKY LOUNGE TABLE 242
					
VEGAS TABLE 256	VEGAS TABLE MEDIUM 258	VEGAS TABLE XL 260	VEGAS BAR 100 262	SKY FOLDING TABLE 60 264	SKY FOLDING TABLE Ø60 266

						
PACIFIC LOUNGE SOFA ARMCHAIR 156	PACIFIC LOUNGE SOFA CHAIR 158	MYKONOS LOUNGE SET XL 160		MYKONOS LOUNGE SET 164		
		SUNLOUNGER ▶				
MYKONOS CUSHIONS 180				SLIM 182	TROPIC 184	
						
TOM BAR 65 196	TOM BAR 75 198	VICTOR BAR 75 200	VICTOR BAR 65 202	CROSS BAR 75 204	CROSS BAR 65 206	
						
OPERA BAR 65 220	CHIAVARI BAR 75 222	CHIAVARI BAR 65 224	FOX 75 226	FOX 65 228	AIR BAR 75 230	
			TABLES ▶			
BOX TABLE 244	OCEAN SIDE TABLE 246	OCEAN TABLE 248			ATLANTIC TABLE 140/210 252	ATLANTIC TABLE 210/280 254
						
SKY TABLE 70 268	SKY TABLE 80 270	SKY TABLE Ø105 272	MAX TABLE 70 274	MAX TABLE Ø90 276	MAX TABLE 140 278	

# CHECKLIST OF OBJECTS

					
MAX TABLE 180 280	AIR TABLE 80 282	AIR TABLE 140 284	AIR TABLE 180 286	SKY FOLDING LEGS 288	SKY LEGS 290
					
MAX LEGS SMALL 292	MAX LEGS MEDIUM 292	MAX LEGS XL 292	AIR LEGS SMALL 294	AIR LEGS MEDIUM 294	AIR LEGS XL 294
					
OCTOPUS 60 296	OCTOPUS BAR 298	SKY FOLDING BAR TABLE 60 300	SKY FOLDING BAR TABLE Ø60 302	ARES 80 304	ARES 140 306
					
MAYA 80 308	MAYA 120 308	MAYA 140 308	ICE 314	ICE 314	ICE LEG&BASE 318
					
MANGO 320	MANGO ALU 322	FORZA 324	SORTIE 326	POPPY 328	ELFO 330
LIGHTING →				<p><b>Siesta</b> exclusive</p> <p>siesta.com.tr</p>	
	DODO 334	NOVA 336	SMART 338		

chairs

lounges & sunloungers

stools & complements

tables

lighting

index



chairs



Paris stacking armchair is produced with a single injection of polypropylene reinforced with glass fiber obtained by means of the latest generation of air moulding technology with neutral tones. For indoor and outdoor use.

282 Paris



Colors



White Black Dark Grey Taupe Olive Green



Marsala





Helen stacking chair is produced with a single injection of polypropylene reinforced with glass fiber obtained by means of the latest generation of air moulding technology with neutral tones. For indoor and outdoor use.

## 284 Helen

CATAS  
TEST REPORT



## Colors



White

Black

Dark Grey

Taupe

Olive Green



Marsala





## Pacific Lounge Armchair



Pacific stacking lounge armchair with Batyline fabric from Serge Ferrari is made from a weather-proof, UV-protected resin reinforced by glass fiber that stands up to summer showers and strong sun, making it the ideal, worry-free addition to your outdoor seating area. For domestic or commercial use.

## 232 Pacific Lounge Armchair

CATAS  
TEST REPORT  
330576

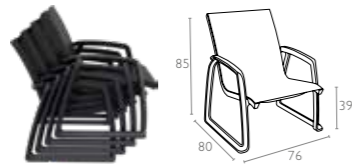

**Serge Ferrari**

## Colors



White / White    Black / Black    Taupe / Taupe    Dark Grey / Black



## Pacific Lounge Chair



Pacific stacking lounge chair with Batoryline fabric from Serge Ferrari is made from a weather-proof, UV-protected resin reinforced by glass fiber that stands up to summer showers and strong sun, making it the ideal, worry-free addition to your outdoor seating area. For domestic or commercial use.

## 231 Pacific Lounge Chair

CATAS  
TEST REPORT  
330575

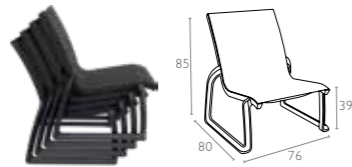

**Serge Ferrari**

## Colors



White / White

Black / Black

Taupe / Taupe

Dark Grey / Black



# Pacific Armchair



Pacific armchair with Batyline fabric from Serge Ferrari is made from a weather-proof, UV-protected resin reinforced by glass fiber that stands up to summer showers and strong sun, making it the ideal, worry-free addition to your outdoor seating area. This versatile armchair pairs perfectly with the Pacific sunlounger, as well as a wide range of other outdoor tables. For domestic or commercial use.

023 Pacific Armchair

CATAS  
TEST REPORT  
308018

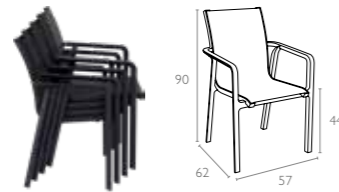

**Serge Ferrari**

Colors



White / White    Black / Black    Taupe / Taupe    Dark Grey / Black



# Sky Pro



Sky Pro stacking armchair is produced with a single injection of polypropylene reinforced with glass fiber obtained by means of the latest generation of air moulding technology with neutral tones. For indoor and outdoor use.

151 Sky Pro

CATAS  
TEST REPORT  
326232

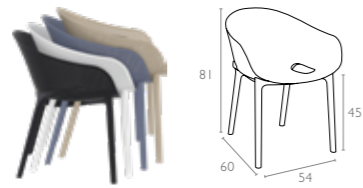

Colors



White    Black    Dark Grey    Taupe    Olive Green



Marsala





Sky armchair is produced with recyclable polypropylene seat and legs reinforced with glass fiber. For indoor and outdoor use. Can be disassembled.

102 Sky

CATAS  
TEST REPORT  
261210

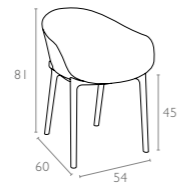

Colors



White Black Dark Grey Taupe Red



Yellow



# Sky Lounge



Sky lounge chair is produced with recyclable polypropylene seat and legs reinforced with glass fiber. For indoor and outdoor use. Can be disassembled. The SKY collection also includes a coffee table, designed to match the styling silhouette of the chair to perfection.

## 103 Sky Lounge

CATAS  
TEST REPORT  
257287

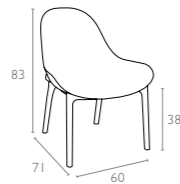

### Colors



White

Black

Dark Grey

Taupe

Red



Yellow





Marie stacking chair is produced with a single injection of polypropylene reinforced with glass fiber obtained by means of the latest generation of air moulding technology with neutral tones. For indoor and outdoor use.

## 251 Marie

CATAS  
TEST REPORT  
294904



## Colors



White



Black



Olive Green





Victor stacking chair is produced with a single injection of polypropylene reinforced with glass fiber obtained by means of the latest generation of air moulding technology with neutral tones. For indoor and outdoor use.

## 252 Victor

CATAS  
TEST REPORT  
294905

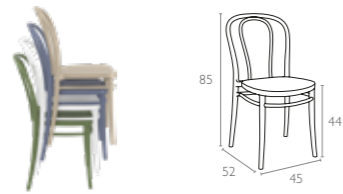

## Colors



White

Black

Dark Grey

Taupe

Olive Green





# Victor XL



Victor XL stacking armchair is produced with a single injection of polypropylene reinforced with glass fiber obtained by means of the latest generation of air moulding technology with neutral tones. For indoor and outdoor use.

253 Victor XL

CATAS  
TEST REPORT  
294886

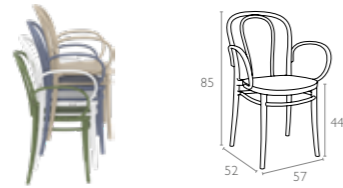

Colors



White    Black    Dark Grey    Taupe    Olive Green





Cross stacking chair is produced with a single injection of polypropylene reinforced with glass fiber obtained by means of the latest generation of air moulding technology with neutral tones. For indoor and outdoor use.

## 254 Cross

CATAS  
TEST REPORT  
294906

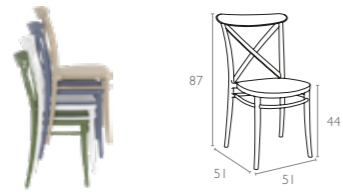

## Colors



White

Black

Dark Grey

Taupe

Olive Green



## Cross XL



Cross XL stacking armchair is produced with a single injection of polypropylene reinforced with glass fiber obtained by means of the latest generation of air moulding technology with neutral tones. For indoor and outdoor use.

## 256 Cross XL

CATAS  
TEST REPORT  
294885

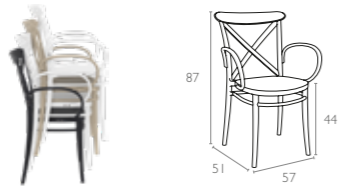

## Colors





Marcel stacking chair is produced with a single injection of polypropylene reinforced with glass fiber obtained by means of the latest generation of air moulding technology with neutral tones. For indoor and outdoor use.

## 257 Marcel

CATAS  
TEST REPORT  
294903

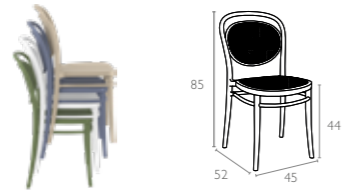

## Colors



White

Black

Dark Grey

Taupe

Olive Green



Marsala



# Marcel XL



Marcel XL stacking armchair is produced with a single injection of polypropylene reinforced with glass fiber obtained by means of the latest generation of air moulding technology with neutral tones. For indoor and outdoor use.

## 258 Marcel XL

CATAS  
TEST REPORT  
294887

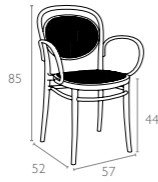

### Colors



White

Black

Dark Grey

Taupe

Olive Green



Marsala





Dream folding chair is produced with a single injection of polypropylene reinforced with glass fiber obtained by means of the latest generation of air moulding technology with neutral tones. For indoor and outdoor use.

## 079 Dream

CATAS  
TEST REPORT  
294880

designed by  
Frédéric Boonen  
**bds**

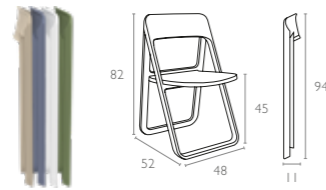

## Colors



White Black Dark Grey Taupe Red



Olive Green





Monna chair is produced with a single injection of polypropylene reinforced with glass fiber obtained by means of the latest generation of air moulding technology with neutral tones. For indoor and outdoor use.

127 Monna

CATAS  
TEST REPORT  
276554

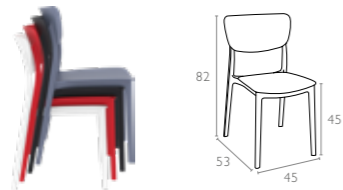

Colors



White

Black

Dark Grey

Taupe

Red



Olive Green





Lisa armchair is produced with a single injection of polypropylene reinforced with glass fiber obtained by means of the latest generation of air moulding technology with neutral tones. For indoor and outdoor use.

126 Lisa

CATAS  
TEST REPORT  
276570

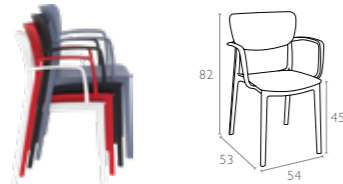

Colors



White Black Dark Grey Taupe Red



Olive Green







Lucy chair is produced with a single injection of polypropylene reinforced with glass fiber obtained by means of the latest generation of air moulding technology with neutral tones. For indoor and outdoor use.

129 Lucy

CATAS  
TEST REPORT  
276562



Colors



White

Black

Dark Grey

Taupe

Olive Green





Loft armchair is produced with a single injection of polypropylene reinforced with glass fiber obtained by means of the latest generation of air moulding technology with neutral tones. For indoor and outdoor use.

128 Loft

CATAS  
TEST REPORT  
276563

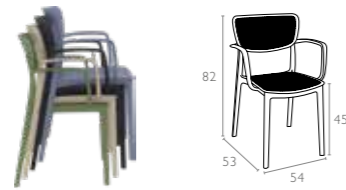

Colors



White

Black

Dark Grey

Taupe

Olive Green





Mila armchair is produced with a single injection of polypropylene reinforced with glass fiber obtained by means of the latest generation of air moulding technology with neutral tones. For indoor and outdoor use.



085 Mila

CATAS  
TEST REPORT  
233341



Colors



White

Black

Dark Grey

Taupe

Red



Yellow





Pia chair is produced with a single injection of polypropylene reinforced with glass fiber obtained by means of the latest generation of air moulding technology with neutral tones. For indoor and outdoor use.



086 Pia

CATAS  
TEST REPORT  
233342



Colors



White

Black

Dark Grey

Taupe

Red



Yellow





Sunset chair is produced with a single injection of polypropylene reinforced with glass fiber obtained by means of the latest generation of air moulding technology with neutral tones. For indoor and outdoor use.



088 Sunset

CATAS  
TEST REPORT  
233343

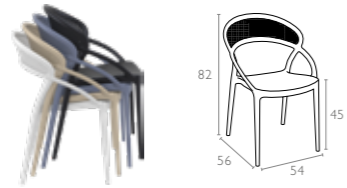

Colors



White

Black

Dark Grey

Brown

Taupe





Plus armchair is produced with a single injection of polypropylene reinforced with glass fiber obtained by means of the latest generation of air moulding technology with neutral tones. For indoor and outdoor use.

093 Plus

CATAS  
TEST REPORT  
235829

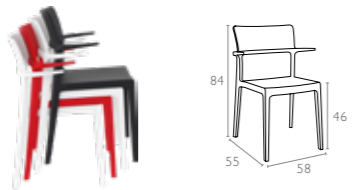

Colors



White

Black

Red





Snow chair is produced with a single injection of polypropylene reinforced with glass fiber obtained by means of the latest generation of air moulding technology with neutral tones. For indoor and outdoor use.

092 Snow

CATAS  
TEST REPORT  
235827

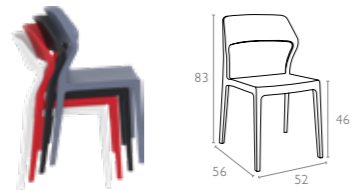

Colors



White Black Dark Grey Taupe Red



Yellow Olive Green Marsala new color





Stacking chair with the latest generation of air moulding thermoplastic injection. Seat in polypropylene reinforced with glass fiber, backrest in transparent polycarbonate. For indoor and outdoor use.

090 Moon

CATAS  
TEST REPORT  
235828

Made with  
**Makrolon®**  
The high-tech polycarbonate

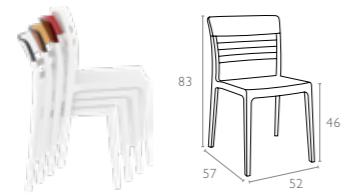

Colors

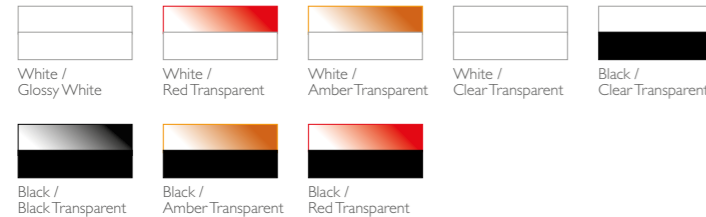





Stacking chair with the latest generation of air moulding thermoplastic injection. Seat in polypropylene reinforced with glass fiber, backrest in transparent polycarbonate. For indoor and outdoor use.

## 091 Flash

CATAS  
TEST REPORT  
235828

Made with  
**Makrolon®**  
The high-tech polycarbonate

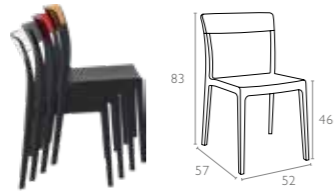

## Colors

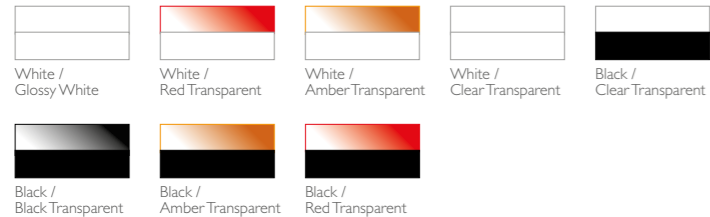



Bloom chair is produced with a single injection of polypropylene reinforced with glass fiber obtained by means of the latest generation of air moulding technology with neutral tones. For indoor and outdoor use.

#### 048 Bloom

CATAS  
TEST REPORT  
207974

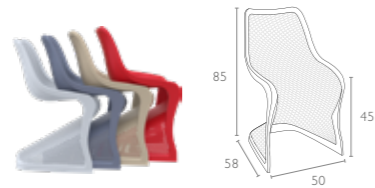

#### Colors



White Black Dark Grey Silver Grey Taupe



Red Yellow





Air XL armchair is produced with a single injection of polypropylene reinforced with glass fiber obtained by means of the latest generation of air moulding technology with neutral tones. For indoor and outdoor use.

007 Air XL

CATAS  
TEST REPORT  
182331

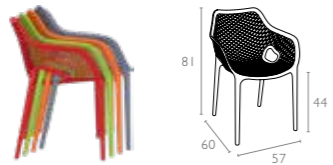

Colors



White Black Dark Grey Red Taupe



Tropical Green Orange Yellow





Air chair is produced with a single injection of polypropylene reinforced with glass fiber obtained by means of the latest generation of air moulding technology with neutral tones. For indoor and outdoor use.

014 Air

CATAS  
TEST REPORT  
163635



Colors



White

Black

Dark Grey

Red

Taupe



Tropical Green



Orange



Yellow





Miranda chair is produced with a single injection of polypropylene reinforced with glass fiber obtained by means of the latest generation of air moulding technology with neutral tones. For indoor and outdoor use.

#### 039 Miranda

CATAS  
TEST REPORT  
201779



#### Colors



White

Black

Dark Grey

Brown

Taupe





Soho chair is produced with a single injection of polypropylene reinforced with glass fiber obtained by means of the latest generation of air moulding technology with neutral tones. For indoor and outdoor use.

054 Soho

CATAS  
TEST REPORT  
201772

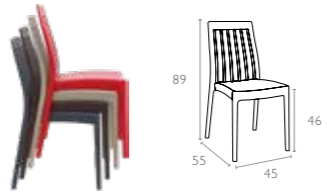

Colors



White

Black

Dark Grey

Brown

Taupe



Red



# Josephine



Josephine wedding chair is produced with a single injection of polypropylene reinforced with glass fiber obtained by means of the latest generation of air moulding technology with neutral tones. For indoor and outdoor use.

050 Josephine

CATAS  
TEST REPORT  
201775

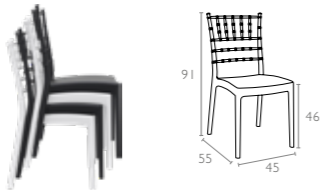

Colors



White

Black





Napoleon wedding chair is produced with a single injection of polypropylene reinforced with glass fiber obtained by means of the latest generation of air moulding technology with neutral tones. For indoor and outdoor use.

044 Napoleon

CATAS  
TEST REPORT  
201775

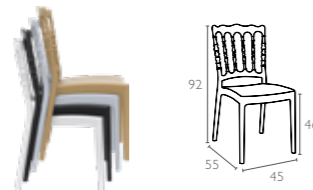

Colors



White

Black

Silver Grey

Gold







Stacking wedding chair for indoor and outdoor use in clear or shiny polycarbonate. Scratch resistant, UV - resistant.

061 Opera

CATAS  
TEST REPORT  
226345

Made with  
**Makrolon®**  
The high-tech polycarbonate

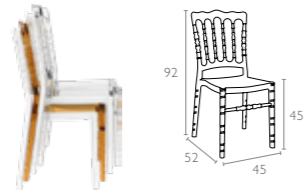

Colors



Glossy White

Amber Transparent

Clear Transparent



## Chiavari



Stacking wedding chair for indoor and outdoor use in clear or shiny polycarbonate. Scratch resistant, UV - resistant.

071 Chiavari

CATAS  
TEST REPORT  
226347

Made with  
**Makrolon®**  
The high-tech polycarbonate

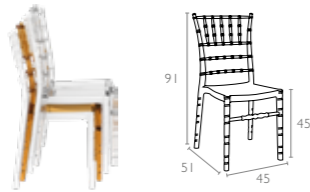

Colors



Glossy White

Amber Transparent

Clear Transparent





Stacking armchair for indoor and outdoor use in clear polycarbonate moulded with gas technology of the second generation. Scratch resistant, UV - resistant.

## 052 Crystal

CATAS  
TEST REPORT  
108091

Made with  
**Makrolon®**  
The high-tech polycarbonate

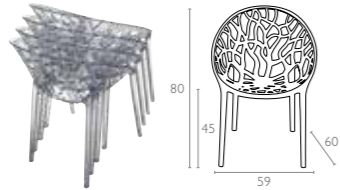

## Colors

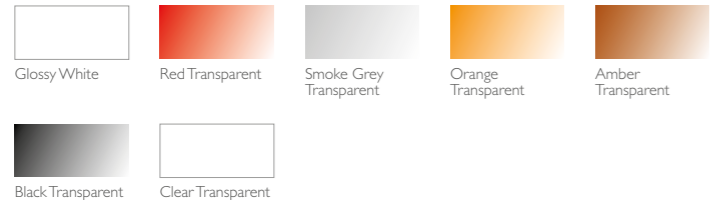



Stacking chair for indoor and outdoor use in shiny technopolymer PA6 nylon or clear polycarbonate. Scratch resistant, self - extinguish classification V2, UV - resistant.

#### 034 Elizabeth

CATAS  
TEST REPORT  
107368

Made with  
**Makrolon®**  
The high-tech polycarbonate

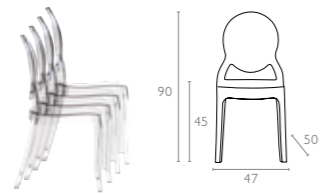

#### Colors

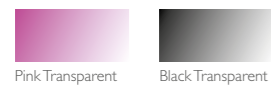



Stacking children chair Baby Elizabeth for indoor and outdoor use in clear polycarbonate. Scratch resistant, UV – resistant.

#### 051 Baby Elizabeth

CATAS  
TEST REPORT  
120253

Made with  
**Makrolon®**  
The high-tech polycarbonate

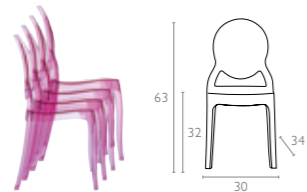

#### Colors

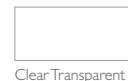

Clear Transparent





Stacking chair for indoor use with removable cushion on the seat, in shiny technopolymer PA6 nylon or clear polycarbonate.

034 Elizabeth-C

CATAS  
TEST REPORT  
107368

Made with  
**Makrolon®**  
The high-tech polycarbonate

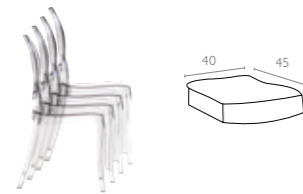

Cushion Colors

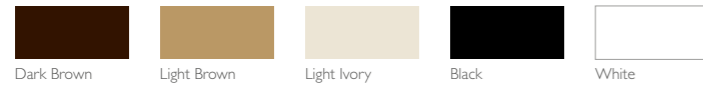

Dark Brown

Light Brown

Light Ivory

Black

White





Stacking armchair for indoor and outdoor use in shiny technopolymer PA6 nylon or clear polycarbonate. Scratch resistant, self-extinguishing classification V2, UV-resistant.

053 Arthur

CATAS  
TEST REPORT  
129749

Made with  
**Makrolon®**  
The high-tech polycarbonate

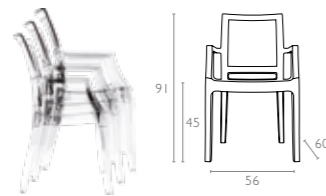

Colors

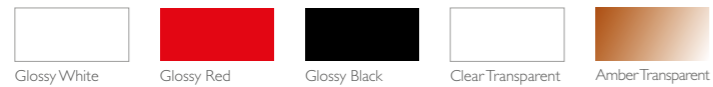

Glossy White

Glossy Red

Glossy Black

Clear Transparent

Amber Transparent



Black Transparent





Stacking chair for indoor and outdoor use in clear or shiny polycarbonate. Scratch resistant, UV - resistant.

005 Bo

CATAS  
TEST REPORT  
154712

Made with  
**Makrolon®**  
The high-tech polycarbonate

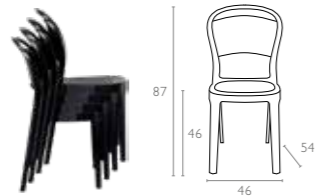

Colors

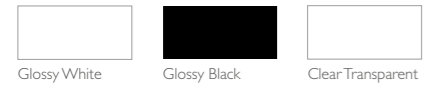

Glossy White   Glossy Black   Clear Transparent





# Bee



Stacking chair for indoor and outdoor use in clear or shiny polycarbonate. Scratch resistant, UV - resistant.

Design By  
**IO**  
ILANIT OVADYA

021 Bee

CATAS  
TEST REPORT  
154712

Made with  
**Makrolon**<sup>®</sup>  
The high-tech polycarbonate

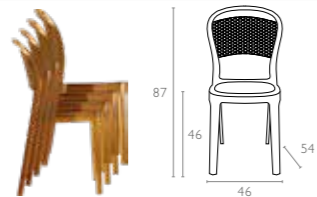

Colors



Clear Transparent



# Miss Bibi



Stacking chair with the latest generation of air moulding thermoplastic injection. Seat in polypropylene reinforced with glass fiber, backrest in transparent polycarbonate. For indoor and outdoor use.

055 Miss Bibi

CATAS  
TEST REPORT  
112744

Made with  
**Makrolon®**  
The high-tech polycarbonate

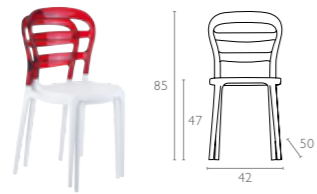

Colors





Stacking chair with the latest generation of air moulding thermoplastic injection. Seat in polypropylene reinforced with glass fiber, backrest in transparent polycarbonate. For indoor and outdoor use.

056 Mr Bobo

CATAS  
TEST REPORT  
112744

Made with  
**Makrolon®**  
The high-tech polycarbonate



Colors

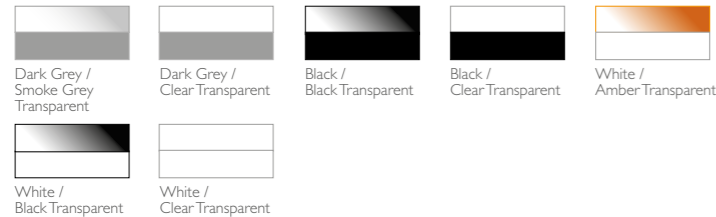



Stacking armchair with the latest generation of air moulding thermoplastic injection. Seat in polypropylene reinforced with glass fiber, backrest in transparent polycarbonate. For indoor and outdoor use.

## 059 Carmen

CATAS  
TEST REPORT  
120254

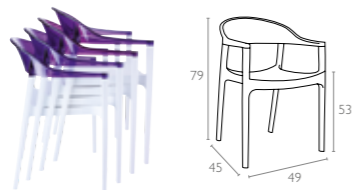

Made with  
**Makrolon®**  
The high-tech polycarbonate

## Colors

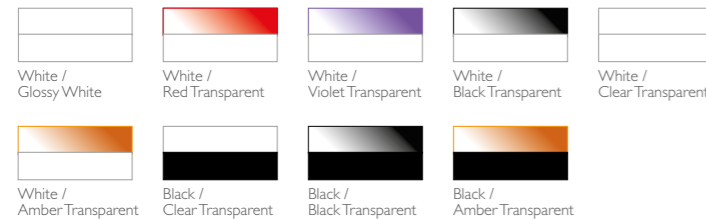

## Allegra



Recyclable polycarbonate main body. Legs frame in tubular chrome steel. Stackable. For indoor use.

057 Allegra

Made with  
**Makrolon®**  
The high-tech polycarbonate

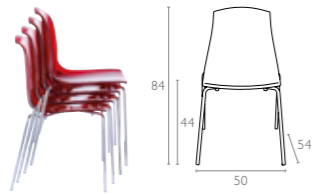

Colors



Glossy White Red Transparent Amber Transparent Black Transparent Clear Transparent





Recyclable polycarbonate main body. Legs frame in polypropylene.  
For indoor and outdoor use. Can be disassembled.

096 Allegra-PP

Made with  
**Makrolon®**  
The high-tech polycarbonate

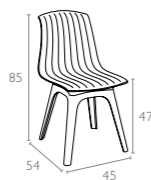

Colors

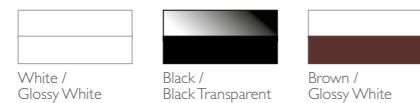

White /  
Glossy White

Black /  
Black Transparent

Brown /  
Glossy White





Mio-PP chair is produced with recyclable polypropylene seat and legs reinforced with glass fiber. For indoor and outdoor use. Can be disassembled.

094 Mio-PP

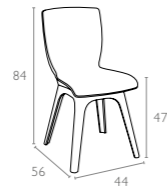

Colors

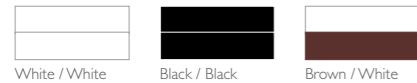

White / White

Black / Black

Brown / White





Stacking chair with recyclable polypropylene seat and backrest and painted steel legs. For indoor use.

046 Mio

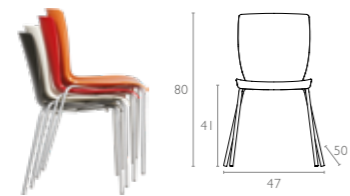

Colors



Black

Orange

Red

Beige

White







The latest generation air moulding process, as used for Maya, allows perfect control for the channel draining and the wall thickness. In designing Maya, the designers developed a formally characterized shape yet suitable for different ambiances - contemporary, classic, informal or elegant - where it easily settles in, thanks to a colour range including brights as well as neutral tones. For indoor and outdoor use.

#### 025 Maya

CATAS  
TEST REPORT  
73610



#### Colors

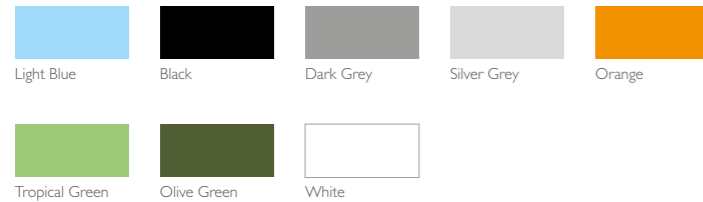



Diva armchair is produced with a single injection of polypropylene reinforced with glass fiber obtained by means of the latest generation of air moulding technology with neutral tones. For indoor and outdoor use.

## 028 Diva

CATAS  
TEST REPORT  
101128

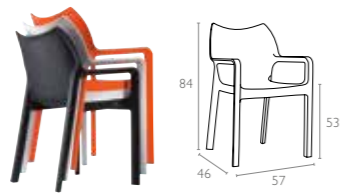

## Colors





Recyclable polypropylene stacking armchair, strong and stable.  
Suitable for outdoor contract use.

## 058 Box

CATAS  
TEST REPORT  
117039

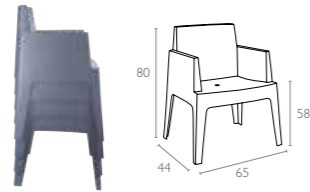

## Colors



## Box Sofa



Recyclable polypropylene stackable sofa, very sturdy and stable.  
Suitable for outdoor contract use.

## 063 Box Sofa

CATAS  
TEST REPORT  
152392

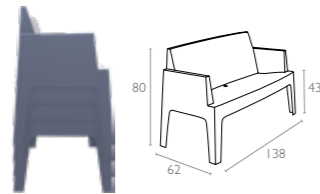

## Colors





Ares chair is produced with a single injection of polypropylene reinforced with glass fiber obtained by means of the latest generation of air moulding technology with neutral tones. For indoor and outdoor use.

## 009 Ares

CATAS  
TEST REPORT  
163637

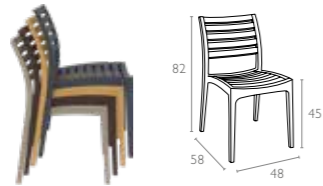

## Colors



White

Black

Dark Grey

Silver Grey

Brown



Taupe



Teak





Artemis armchair is produced with a single injection of polypropylene reinforced with glass fiber obtained by means of the latest generation of air moulding technology with neutral tones. For indoor and outdoor use.

## 011 Artemis

CATAS  
TEST REPORT  
163636

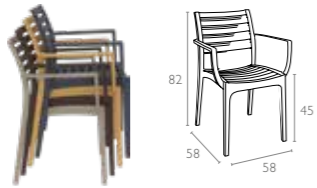

## Colors



White

Black

Dark Grey

Silver Grey

Brown



Taupe



Teak



## Artemis XL



Artemis XL Lounge armchair is stackable and produced with a single injection of polypropylene reinforced with glass fiber, for indoor and outdoor use with or without cushion and non-slip feet. The Artemis collection also includes a coffee table, in various sizes, designed to match the styling silhouette of the chair to perfection.

## 004 Artemis XL

CATAS  
TEST REPORT  
184080

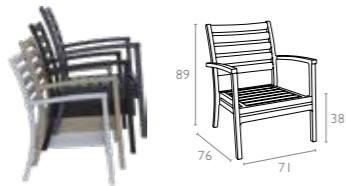

## Colors



Black

Dark Grey

Silver Grey

Taupe

White





Tiffany chair is produced with a single injection of polypropylene reinforced with glass fiber obtained by means of the latest generation of air moulding technology with neutral tones. Stackable. For indoor and outdoor use.

## 018 Tiffany

CATAS  
TEST REPORT  
135690

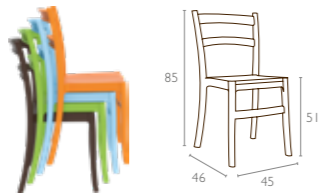

## Colors





## Tiffany-S



Tiffany-S chair is produced with a single injection of polypropylene reinforced with glass fiber obtained by means of the latest generation of air moulding technology with neutral tones. Stackable. For indoor and outdoor use.

019 Tiffany-S

CATAS  
TEST REPORT  
135690

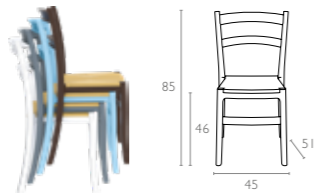

Colors



Brown

Dark Grey

Light Blue

White





Stacking chair with the latest generation of air moulding thermoplastic injection. For indoor and outdoor use.

026 Lucca

CATAS  
TEST REPORT  
85006

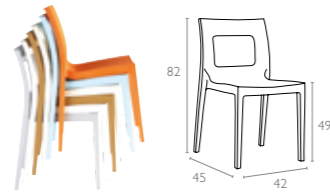

Colors



Light Blue

Dark Grey

Silver Grey

Orange

Tropical Green

White





Stacking chair with the latest generation of air moulding thermoplastic injection. Back in transparent polycarbonate.  
For indoor and outdoor use.

029 Lucca-T

Made with  
**Makrolon®**  
The high-tech polycarbonate

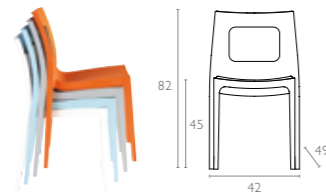

Colors



Light Blue

Orange

White





Stacking armchair with recyclable polypropylene seat and backrest and anodized aluminium legs. Diameter 25 mm. For indoor and outdoor use.

047 Dolce

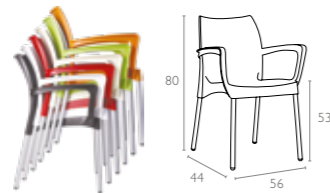

Colors



Black

Light Green

Orange

Red

Beige



Dark Grey



White





Stacking chair with recyclable polypropylene seat and backrest and anodized aluminium legs. Diameter 25 mm.  
For indoor and outdoor use.

## 049 Vita

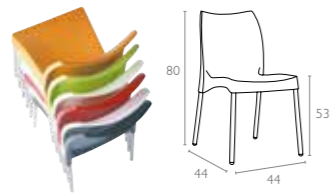

## Colors



Black    Light Green    Orange    Red    Beige



Dark Grey    White





Stacking armchair with recyclable polypropylene seat and backrest and anodized aluminium legs. Diameter 25 mm. For indoor and outdoor use.

## 043 Romeo



## Colors



Blue

Black

Light Green

Orange

Red



Beige



White





Stacking chair with recyclable polypropylene seat and backrest and anodized aluminium legs. Diameter 25 mm.  
For indoor and outdoor use.

045 Juliette

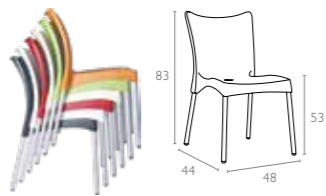

Colors



Blue

Black

Light Green

Orange

Red



Beige

White





Stacking armchair in anodized aluminium with seat and back in recyclable polypropylene with latest generation of air moulding thermoplastic injection. Diameter 25 mm. For indoor and outdoor use.

041 Gala

CATAS  
TEST REPORT  
79261

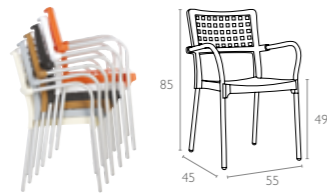

Colors



Teak

Orange

White







Stacking armchair in anodized aluminium with seat and back in recyclable polypropylene with latest generation of air moulding thermoplastic injection. Diameter 25 mm. For indoor and outdoor use.

040 Bella

CATAS  
TEST REPORT  
79261

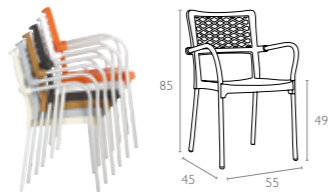

Colors



Teak

Orange

White



## Artemis XL Cushions



5 cm thick seat and backrest cushion covered with polyester fabric and finished with piping. Cushion is specially designed for Artemis XL armchair.

899 Artemis XL Seat Cushion

900 Artemis XL Backrest Cushion

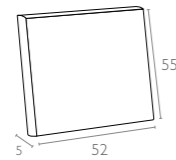
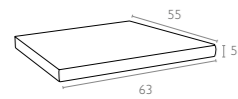

## Cushion Colors



White



Beige



Light Grey



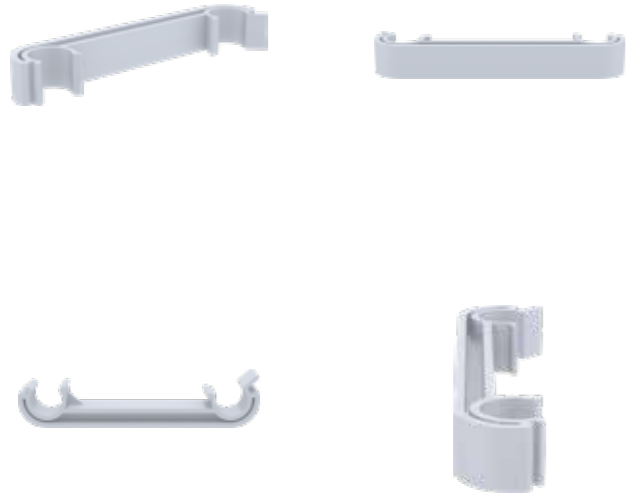

Link linking device in polypropylene to be fixed on the frame.  
Suitable for all round legs  $\varnothing$  25mm.

097 Link

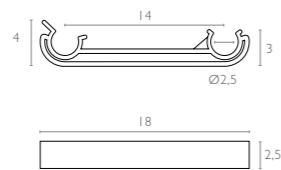

Colors



Silver Grey





# lounge & sunlounger

# Pacific Lounge Set With Arms



Pacific Lounge Set with arms is designed for easy self assembly, it is made of durable weather-resistant resin reinforced with glass fiber with Batyline fabric from Serge Ferrari. Non-metallic frame will never unravel, rust or decay. It is UV protected which insures the colors will not fade. For indoor and outdoor use. Can be purchased as set or separately.

Pacific Lounge Armchair

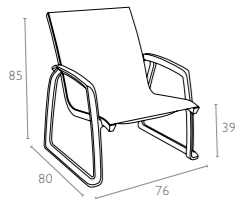

Pacific Lounge Sofa Armchair

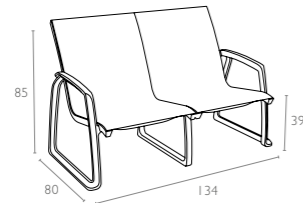

Sky Lounge Table

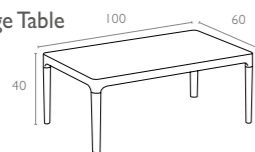

238 Pacific Lounge Set With Arms

Colors

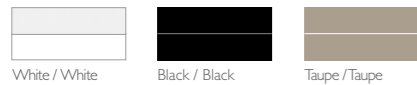

White / White    Black / Black    Taupe / Taupe



# Pacific Lounge Set Without Arms



Pacific Lounge Set without arms is designed for easy self assembly, it is made of durable weather-resistant resin reinforced with glass fiber with Batyline fabric from Serge Ferrari. Non-metallic frame will never unravel, rust or decay. It is UV protected which insures the colors will not fade. For indoor and outdoor use. Can be purchased as set or separately.

Pacific Lounge Chair

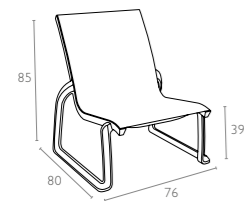

Pacific Lounge Sofa Chair

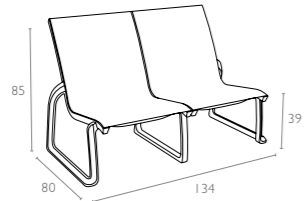

Sky Lounge Table

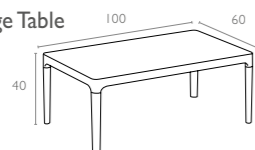

237 Pacific Lounge Set Without Arms

Colors



White / White    Black / Black    Taupe / Taupe



# Pacific Lounge Extension Part



With the Pacific Lounge extension part you can add as many seats as you want to extend your Pacific Lounge Sofa with Batyline fabric from Serge Ferrari.

236 Pacific Lounge Extension Part

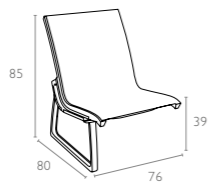

**Serge Ferrari**

Colors



White / White    Black / Black    Taupe / Taupe



## Pacific Lounge Sofa Armchair



Pacific Lounge sofa with arms designed for easy self assembly with Batyline fabric from Serge Ferrari is made from a weather-proof, UV-protected resin reinforced by glass fiber that stands up to summer showers and strong sun, making it the ideal, worry-free addition to your outdoor seating area. For domestic or commercial use.

## 234 Pacific Lounge Sofa Armchair

CATAS  
TEST REPORT  
330573

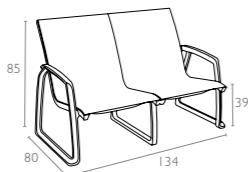

**Serge Ferrari**

## Colors



White / White

Black / Black

Taupe / Taupe





## Pacific Lounge Sofa Chair



Pacific Lounge sofa without arms designed for easy self assembly with Batyline fabric from Serge Ferrari is made from a weather-proof, UV-protected resin reinforced by glass fiber that stands up to summer showers and strong sun, making it the ideal, worry-free addition to your outdoor seating area. For domestic or commercial use.

## 233 Pacific Lounge Sofa Chair

CATAS  
TEST REPORT  
330571

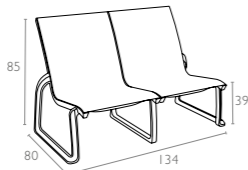

**Serge Ferrari**

Colors



White / White



Black / Black



Taupe / Taupe



# Mykonos Lounge Set XL



Mykonos Lounge Set XL is designed for easy self assembly, it is made of durable weather-resistant resin reinforced with glass fiber. Non-metallic frame will never unravel, rust or decay. It is UV protected which insures the colors will not fade. Can be disassembled. For indoor and outdoor contract use.

Mykonos  
Lounge Armchair

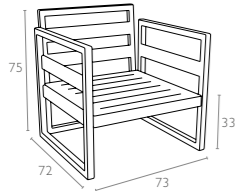

Mykonos  
Lounge Sofa XL

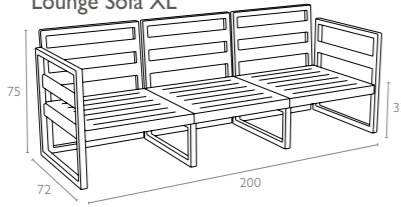

Mykonos  
Lounge Table XL

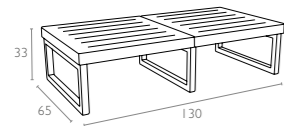

Mykonos  
Seat Cushion

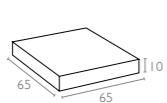

Mykonos  
Backrest Cushion

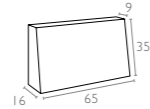

I 33 Mykonos Lounge Set XL

## Colors



White

Taupe

Silver Grey

## Cushions

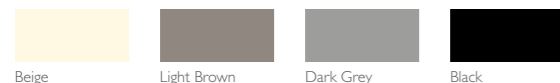

Beige

Light Brown

Dark Grey

Black

**etisilk**  
Outdoor Furniture Fabrics

**CATAS**  
TEST REPORT  
282198





# Mykonos Lounge Set



Mykonos Lounge Set is designed for easy self assembly, it is made of durable weather-resistant resin reinforced with glass fiber. Non-metallic frame will never unravel, rust or decay. It is UV protected which insures the colors will not fade. Can be disassembled. For indoor and outdoor contract use.

Mykonos  
Lounge Armchair

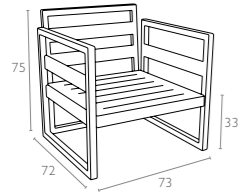

Mykonos  
Lounge Sofa

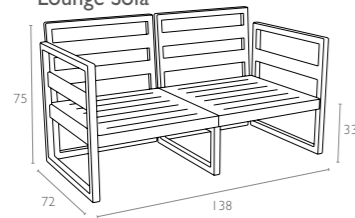

Mykonos  
Lounge Table

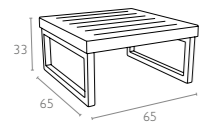

Mykonos  
Seat Cushion

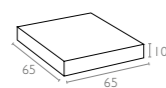

Mykonos  
Backrest Cushion

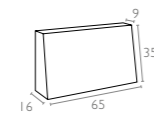

132 Mykonos Lounge Set

## Colors



## Cushions

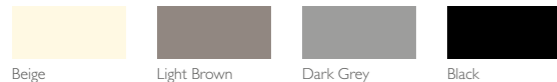

CATAS  
TEST REPORT  
282198

etisilk  
Outdoor Furniture Fabrics





# Mykonos Lounge Corner Set



Mykonos Lounge Corner Set is designed for easy self assembly, it is made of durable weather-resistant resin reinforced with glass fiber. Non-metallic frame will never unravel, rust or decay. It is UV protected which insures the colors will not fade. Can be disassembled. For indoor and outdoor contract use.

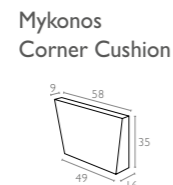
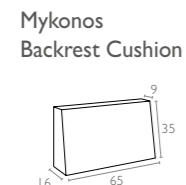
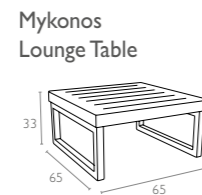
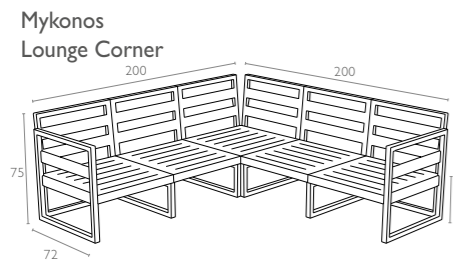

134 Mykonos Lounge Corner Set



**CATAS**  
TEST REPORT  
282200





# Mykonos Lounge Armchair



Mykonos Lounge Armchair is designed for easy self assembly, it is made of durable weather-resistant resin reinforced with glass fiber. Non-metallic frame will never unravel, rust or decay. It is UV protected which insures the colors will not fade. Can be disassembled. For indoor and outdoor contract use.

## 131 Mykonos Lounge Armchair

CATAS  
TEST REPORT  
282199

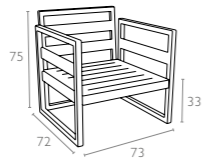

### Colors



White

Taupe

Silver Grey





## Mykonos Lounge Table



Mykonos Lounge Table is made of durable weather-resistant resin. Non-metallic frame will never unravel, rust or decay. It is UV protected which insures the colors will not fade. Can be disassembled. For indoor and outdoor use.

### 137 Mykonos Lounge Table

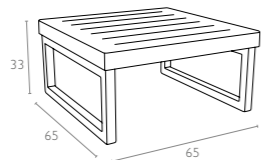

#### Colors



White

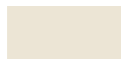

Taupe



Silver Grey



# Mykonos Lounge Table XL



Mykonos Lounge Table XL is made of durable weather-resistant resin. Non-metallic frame will never unravel, rust or decay. It is UV protected which insures the colors will not fade. Can be disassembled. For indoor and outdoor use.

## 138 Mykonos Lounge Table XL

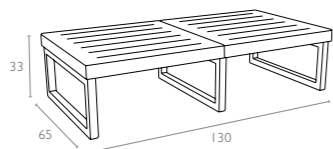

### Colors



White

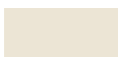

Taupe



Silver Grey



## Mykonos Extension Part



With the extension part you can add as many seats as you want to extend your corner set.

## 136 Mykonos Extension Part

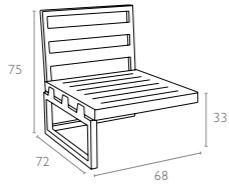

## Colors



White

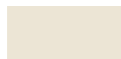

Taupe



Silver Grey



# Mykonos Cushions



10 cm thick cushion covered with Etisilk polyester fabric and finished with piping. Cushions are specially designed for Mykonos Lounge Set. Water resistant with UV.

**etisilk**  
Outdoor Furniture Fabrics

141 Mykonos  
Seat Cushion

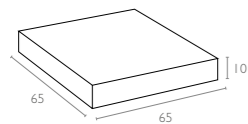

142 Mykonos  
Backrest Cushion

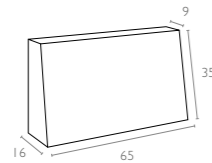

143 Mykonos  
Corner Cushion

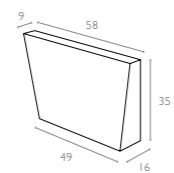

## Cushion Colors

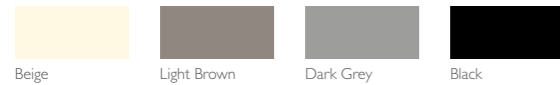

Beige

Light Brown

Dark Grey

Black





Slim sunlounger is stackable and comes with hidden wheels and anti-slippery rubbers. It is made of durable weather-resistant resin. Non metallic frame will never unravel, rust or decay. It is UV protected which insures the colors will not fade. For outdoor use.

087 Slim

CATAS  
TEST REPORT  
308019

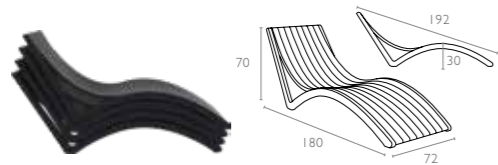

Colors



White

Black

Dark Grey

Taupe





Tropic sunlounger with legs in resin reinforced with glass fiber combined with lacquered aluminium structure. Cover in breathable synthetic replaceable fabric, back reclining in 5 positions, with non-slip feet and small wheels. Two materials combined together to make a very resistant, functional light-weight and stackable sunlounger.

708 Tropic

CATAS  
TEST REPORT

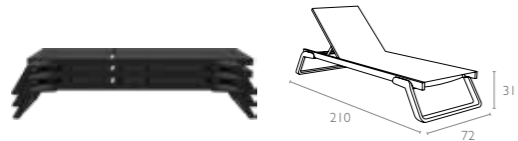

**Serge Ferrari**

Colors



White / White

White / Taupe

Taupe / Taupe

Dark Grey / Black

Black / Black



# Tropic Arm



Armrest for Tropic sunlounger. Arms in resin reinforced with glass fiber. Can be fixed onto the sun lounger frame with the provided screws.

## 709 Tropic Arm

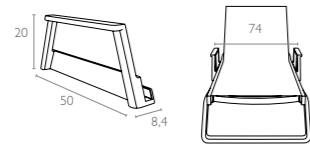

### Colors



White

Black

Dark Grey

Taupe





Sunlounger without arms, tubular frame in resin reinforced with glass fiber and cover in breathable synthetic fabric (replaceable). Stackable, back reclining in 5 positions, with non-slip feet and small wheels.

089 Pacific

CATAS  
TEST REPORT  
178495

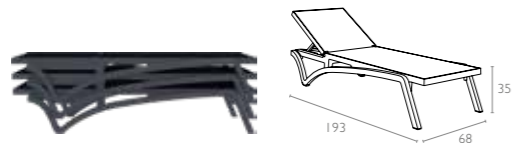

**Serge Ferrari**

Colors

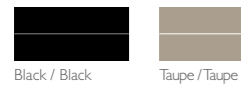
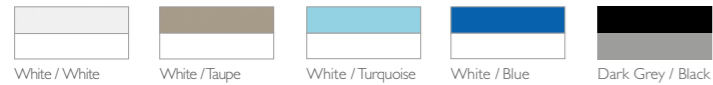



## Slim Cushions

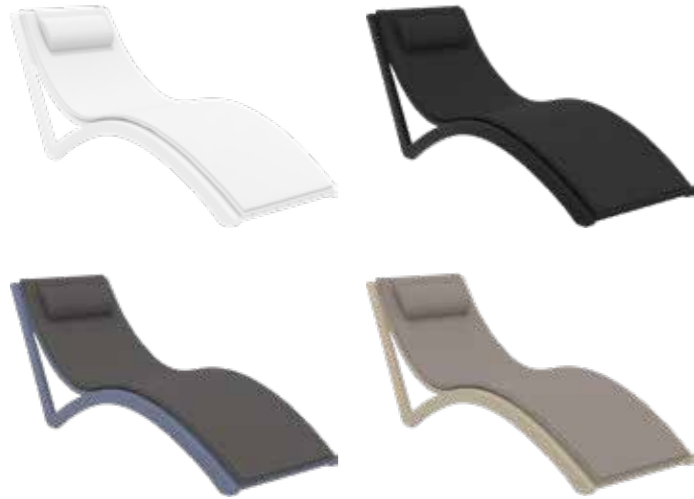

3 cm thick Slim cushion and 5 cm thick Slim pillow cushion covered with Etisilk polyester fabric and finished with piping. Cushions are specially designed for Slim sunlounger. Water resistant with UV.



144 Slim Cushion

148 Slim Pillow Cushion

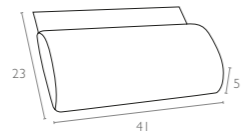
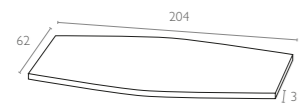

## Cushion Colors

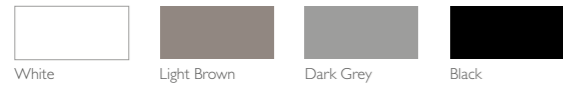

White

Light Brown

Dark Grey

Black



# stools & complements





Tom stacking stool h.45 cm is produced with a single injection of polypropylene reinforced with glass fiber obtained by means of the latest generation of air moulding technology with neutral tones. For indoor and outdoor use.

286 Tom 45

CATAS  
TEST REPORT

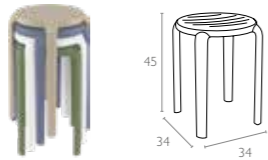

Colors



White

Black

Dark Grey

Taupe

Olive Green



Marsala





Tom bar stool h.65 cm is produced with a single injection of polypropylene reinforced with glass fiber obtained by means of the latest generation of air moulding technology with neutral tones. For indoor and outdoor use.

## 287 Tom Bar 65

CATAS  
TEST REPORT

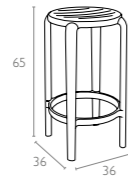

## Colors



White Black Dark Grey Taupe Olive Green



Marsala



# Tom Bar 75



Tom bar stool h.75 cm is produced with a single injection of polypropylene reinforced with glass fiber obtained by means of the latest generation of air moulding technology with neutral tones. For indoor and outdoor use.

288 Tom Bar 75

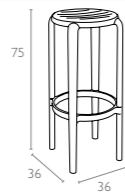

### Colors



White    Black    Dark Grey    Taupe    Olive Green



Marsala



# Victor Bar 75



Victor bar stool h.75 cm is produced with a single injection of polypropylene reinforced with glass fiber obtained by means of the latest generation of air moulding technology with neutral tones. For indoor and outdoor use.

262 Victor Bar 75

**CATAS**  
TEST REPORT  
294882

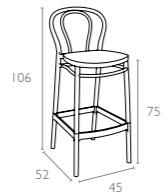

### Colors



# Victor Bar 65



Victor bar stool h.65 cm is produced with a single injection of polypropylene reinforced with glass fiber obtained by means of the latest generation of air moulding technology with neutral tones. For indoor and outdoor use.

## 261 Victor Bar 65

**CATAS**  
TEST REPORT  
294882

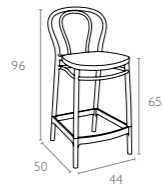

### Colors



# Cross Bar 75



Cross bar stool h.75 cm is produced with a single injection of polypropylene reinforced with glass fiber obtained by means of the latest generation of air moulding technology with neutral tones. For indoor and outdoor use.

266 Cross Bar 75

CATAS  
TEST REPORT  
294881

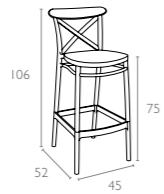

Colors



White    Black    Dark Grey    Taupe    Olive Green





# Cross Bar 65



Cross bar stool h.65 cm is produced with a single injection of polypropylene reinforced with glass fiber obtained by means of the latest generation of air moulding technology with neutral tones. For indoor and outdoor use.

264 Cross Bar 65

**CATAS**  
TEST REPORT  
294881

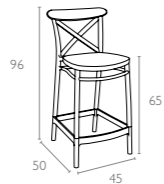

Colors



White    Black    Dark Grey    Taupe    Olive Green



# Marcel Bar 75



Marcel bar stool h.75 cm is produced with a single injection of polypropylene reinforced with glass fiber obtained by means of the latest generation of air moulding technology with neutral tones. For indoor and outdoor use.

## 269 Marcel Bar 75

CATAS  
TEST REPORT  
294883

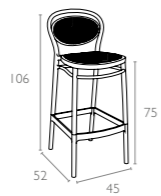

### Colors



Marsala



## Marcel Bar 65



Marcel bar stool h.65 cm is produced with a single injection of polypropylene reinforced with glass fiber obtained by means of the latest generation of air moulding technology with neutral tones. For indoor and outdoor use.

## 268 Marcel Bar 65

CATAS  
TEST REPORT  
294883

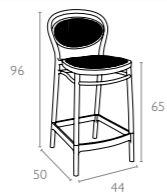

## Colors



White

Black

Dark Grey

Taupe

Olive Green

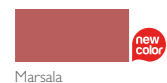

Marsala



## Maya Bar 75



Maya stacking bar stool h.75 cm is produced with a single injection of polypropylene reinforced with glass fiber obtained by means of the latest generation of air moulding technology with neutral tones. For indoor and outdoor use.

099 Maya Bar 75

CATAS  
TEST REPORT  
236234

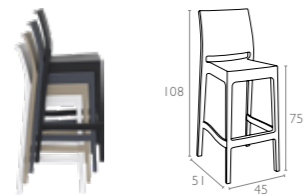

Colors



White

Black

Dark Grey

Taupe

Olive Green



# Maya Bar 65



Maya stacking bar stool h.65 cm is produced with a single injection of polypropylene reinforced with glass fiber obtained by means of the latest generation of air moulding technology with neutral tones. For indoor and outdoor use.

100 Maya Bar 65

CATAS  
TEST REPORT  
236234

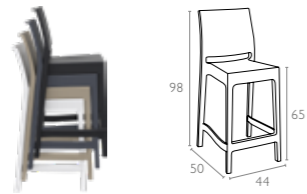

Colors



## Ares Bar 75



Ares stacking bar stool h.75 cm is produced with a single injection of polypropylene reinforced with glass fiber obtained by means of the latest generation of air moulding technology with neutral tones. For indoor and outdoor use.

## 101 Ares Bar 75

CATAS  
TEST REPORT  
236235

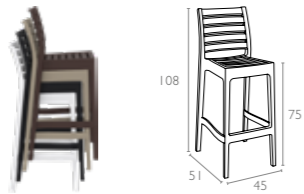

## Colors



White

Black

Dark Grey

Brown

Taupe



## Opera Bar 75



Stacking wedding bar stool h.75 cm for indoor and outdoor use in clear or shiny polycarbonate. Scratch resistant, UV - resistant.

073 Opera Bar 75

CATAS  
TEST REPORT  
226344

Made with  
**Makrolon®**  
The high-tech polycarbonate

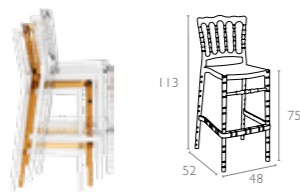

Colors



Glossy White

Amber Transparent

Clear Transparent



# Opera Bar 65



Stacking wedding bar stool h.65 cm for indoor and outdoor use in clear or shiny polycarbonate. Scratch resistant, UV - resistant.

074 Opera Bar 65

CATAS  
TEST REPORT  
226344

Made with  
**Makrolon®**  
The high-tech polycarbonate

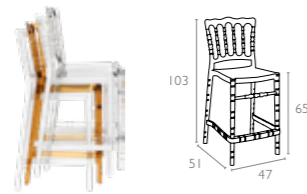

Colors



Glossy White    Amber Transparent    Clear Transparent





# Chiavari Bar 75



Stacking wedding bar stool h.75 cm for indoor and outdoor use in clear or shiny polycarbonate. Scratch resistant, UV - resistant.

083 Chiavari Bar 75

CATAS  
TEST REPORT  
226346

Made with  
**Makrolon®**  
The high-tech polycarbonate

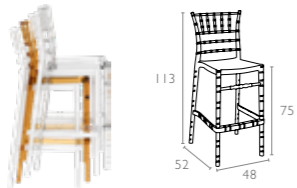

Colors



Glossy White    Amber Transparent    Clear Transparent



# Chiavari Bar 65



Stacking wedding bar stool h.65 cm for indoor and outdoor use in clear or shiny polycarbonate. Scratch resistant, UV - resistant.

084 Chiavari Bar 65

CATAS  
TEST REPORT  
226346

Made with  
**Makrolon®**  
The high-tech polycarbonate

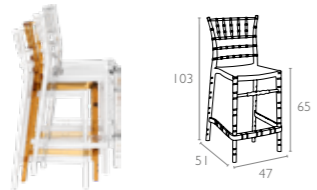

Colors



Glossy White    Amber Transparent    Clear Transparent





Stacking bar stool h.75 cm for indoor and outdoor use in shiny technopolymer PA6 nylon or clear polycarbonate. Scratch resistant, self - extinguish classification V2, UV - resistant.

037 Fox 75

CATAS  
TEST REPORT  
101129

Made with  
**Makrolon®**  
The high-tech polycarbonate



Colors

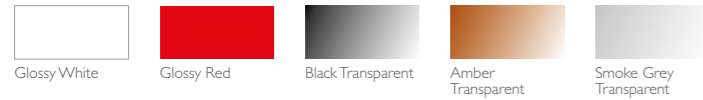

Glossy White

Glossy Red

Black Transparent

Amber  
Transparent

Smoke Grey  
Transparent



Clear Transparent



# Fox 65



Stacking bar stool h.65 cm for indoor and outdoor use in shiny technopolymer PA6 nylon or clear polycarbonate. Scratch resistant, self - extinguish classification V2, UV - resistant.

036 Fox 65

CATAS  
TEST REPORT  
101129



Made with  
**Makrolon®**  
The high-tech polycarbonate

Colors



Glossy White   Glossy Red   Black Transparent   Clear Transparent



## Air Bar 75



Air Bar stool h.75 cm is produced with a single injection of polypropylene reinforced with glass fiber obtained by means of the latest generation of air moulding technology with neutral tones. For indoor and outdoor use.

068 Air Bar 75

CATAS  
TEST REPORT  
184081

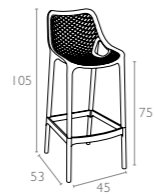

Colors



White

Black

Dark Grey

Red

Taupe



Tropical Green



Orange





Air Bar stool h.65 cm is produced with a single injection of polypropylene reinforced with glass fiber obtained by means of the latest generation of air moulding technology with neutral tones. For indoor and outdoor use.

067 Air Bar 65

CATAS  
TEST REPORT  
184081

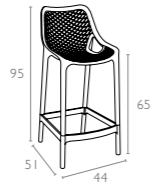

Colors

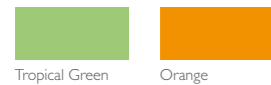



Revolving stool with adjustable height with gas piston. Base and column in stainless steel. Seat in recyclable polycarbonate. For indoor use.

042 Aria

Made with **Makrolon®**  
The high-tech polycarbonate

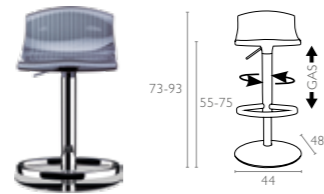

Colors



Glossy White   Red Transparent   Amber Transparent   Black Transparent   Clear Transparent



# Gio 75



Stacking bar stool with recyclable polypropylene seat and backrest and square anodized aluminium legs. Diameter 25x25 mm. For indoor and outdoor use.

035 Gio 75

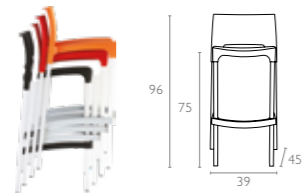

**Colors**



Black

Light Green

Orange

Red

Beige



White





# Queen



Stacking side table for indoor and outdoor use in clear polycarbonate. UV - resistant.

065 Queen

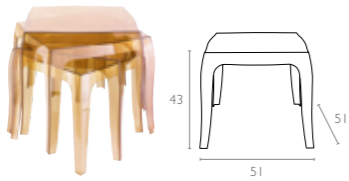

Made with **Makrolon®**  
The high-tech polycarbonate

Colors

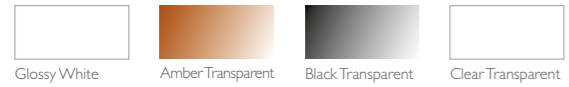

Glossy White    Amber Transparent    Black Transparent    Clear Transparent



# Sky Side Table



Sky Side Table is made of durable weather-resistant resin. Non-metallic frame will never unravel, rust or decay. It is UV protected which insures the colors will not fade. Can be disassembled. For indoor and outdoor use.

109 Sky Side Table

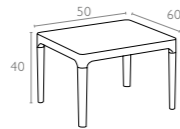

Colors



White    Black    Dark Grey    Taupe    Red



Yellow



# Sky Lounge Table



Sky Table is made of durable weather-resistant resin. Metallic frame will never unravel, rust or decay. It is UV protected which insures the colors will not fade. Can be disassembled. For indoor and outdoor use.

## 104 Sky Lounge Table

CATAS  
TEST REPORT  
257118

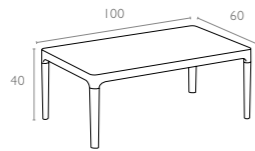

### Colors



White Black Dark Grey Taupe Red



Yellow



# Box Table



Stacking table in recyclable polypropylene.  
For indoor and outdoor use.

## 064 Box Table

---

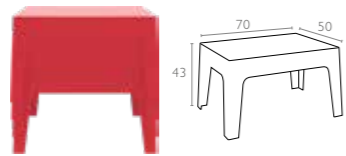

### Colors

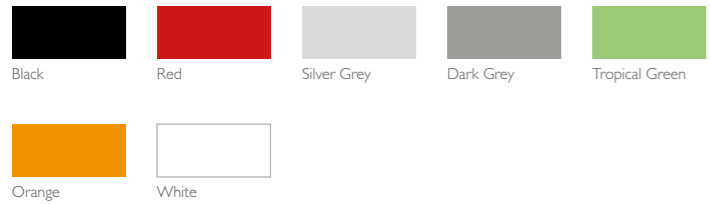

# Ocean Side Table



Ocean Side Table is made of durable weather-resistant resin. Non-metallic frame will never unravel, rust or decay. It is UV protected which insures the colors will not fade. Can be disassembled. For indoor and outdoor use.

066 Ocean Side Table

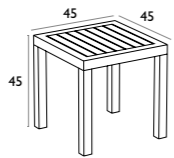

Colors



# Ocean Table



Ocean Lounge Table is made of durable weather-resistant resin. Non-metallic frame will never unravel, rust or decay. It is UV protected which insures the colors will not fade. Can be disassembled. For indoor and outdoor use.

## 069 Ocean Table

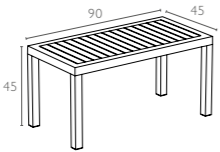

### Colors



Black    Dark Grey    Silver Grey    Taupe    White





tables

# Atlantic Table 140/210



Extendible table from 140 to 210 cm in polypropylene with aluminium frame. Easily expandable, giving you a choice of two size options. Smart extending mechanism makes it easy to adjust the table to your preferred size. For indoor and outdoor use with UV protection.

762 Atlantic Table 140/210

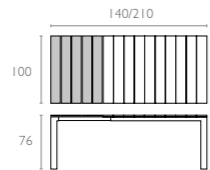

Colors





# Atlantic Table 210/280



Extendible table from 210 to 280 cm in polypropylene with aluminium frame. Easily expandable, giving you a choice of two size options. Smart extending mechanism makes it easy to adjust the table to your preferred size. For indoor and outdoor use with UV protection.

764 Atlantic Table 210/280

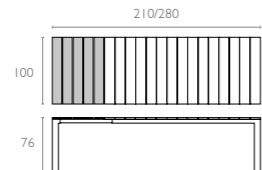

Colors



# Vegas Table



Extendible table from 100 to 140 cm in polypropylene reinforced with glass fiber. Easily expandable, giving you a choice of two size options. Smart extending mechanism makes it easy to adjust the table to your preferred size. For indoor and outdoor use with UV protection.



772 Vegas Table

CATAS  
TEST REPORT  
253099

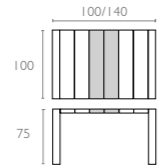

### Colors



White

Black

Dark Grey

Taupe



# Vegas Table Medium



Extendible table from 180 to 220 cm in polypropylene reinforced with glass fiber. Easily expandable, giving you a choice of two size options. Smart extending mechanism makes it easy to adjust the table to your preferred size. For indoor and outdoor use with UV protection.



774 Vegas Table Medium

CATAS  
TEST REPORT  
253098

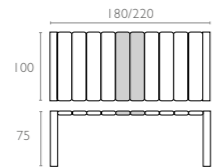

Colors



White

Black

Dark Grey

Taupe



# Vegas Table XL



Extendible table from 260 to 300 cm in polypropylene reinforced with glass fiber. Easily expandable, giving you a choice of two size options. Smart extending mechanism makes it easy to adjust the table to your preferred size. For indoor and outdoor use with UV protection.



776 Vegas Table XL

CATAS  
TEST REPORT  
253097

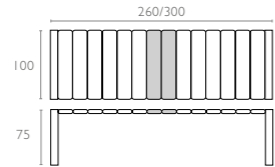

### Colors



White      Black      Dark Grey      Taupe



## Vegas Bar 100



Extendible bar table from 100 to 140 cm in polypropylene reinforced with glass fiber. Easily expandable, giving you a choice of two size options. Smart extending mechanism makes it easy to adjust the bar table to your preferred size. For indoor and outdoor use with UV protection.



782 Vegas Bar 100

CATAS  
TEST REPORT

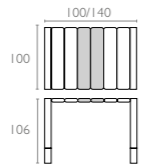

Colors



White

Black

Dark Grey

Taupe



# Sky Folding Table 60



Sky folding table is made of durable weather-resistant resin. Metallic frame will never unravel, rust or decay. It is UV protected which insures the colors will not fade. Can be disassembled. For indoor and outdoor use.

114 Sky Folding Table 60



Colors



White    Black    Dark Grey    Taupe    Olive Green



## Sky Folding Table Ø60



Sky folding table is made of durable weather-resistant resin. Metallic frame will never unravel, rust or decay. It is UV protected which insures the colors will not fade. Can be disassembled. For indoor and outdoor use.

## 121 Sky Folding Table Ø60



## Colors



White

Black

Dark Grey

Taupe

Olive Green



# Sky Table 70



Sky Table is made of durable weather-resistant resin. Metallic frame will never unravel, rust or decay. It is UV protected which insures the colors will not fade. Can be disassembled. For indoor and outdoor use.

108 Sky Table 70

**CATAS**  
TEST REPORT  
336570

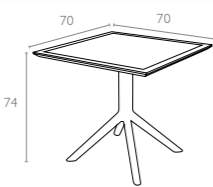

### Colors





# Sky Table 80



Sky Table is made of durable weather-resistant resin. Metallic frame will never unravel, rust or decay. It is UV protected which insures the colors will not fade. Can be disassembled. For indoor and outdoor use.

## 106 Sky Table 80

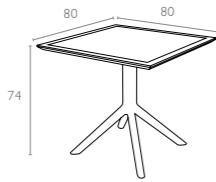

### Colors



## Sky Table Ø105



Sky Table is made of durable weather-resistant resin. Metallic frame will never unravel, rust or decay. It is UV protected which insures the colors will not fade. Can be disassembled. For indoor and outdoor use.

## 124 Sky Table Ø105

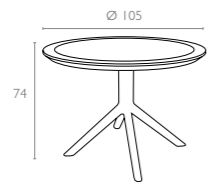

## Colors



White

Black

Dark Grey

Taupe

Olive Green



## Max Table 70

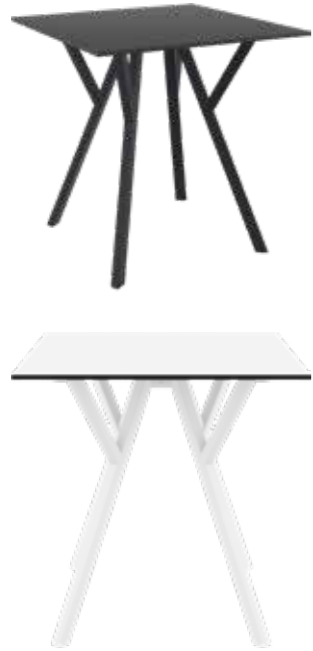
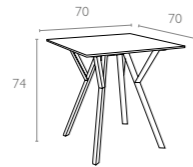

Table with plastic legs with HPL compact laminated tops 12 mm available in white and black. For indoor and outdoor use. Can be disassembled.

*\*Dark colors not recommended in direct sunlight.*

## 742 Max Table 70



## Colors



White



Black



## Max Table Ø90



Table with plastic legs with HPL compact laminated tops 12 mm available in white and black. For indoor and outdoor use. Can be disassembled.

*\*Dark colors not recommended in direct sunlight.*

## 744 Max Table Ø90

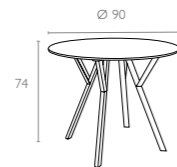

## Colors



White



Black



## Max Table 140



Table with plastic legs with HPL compact laminated tops 12 mm available in white and black. For indoor and outdoor use. Can be disassembled.

*\* Dark colors not recommended in direct sunlight.*

## 746 Max Table 140

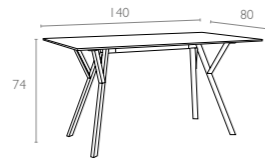

## Colors



White



Black



# Max Table 180



Table with plastic legs with HPL compact laminated tops 12 mm available in white and black. For indoor and outdoor use. Can be disassembled.

*\* Dark colors not recommended in direct sunlight.*

748 Max Table 180



Colors



White



Black



## Air Table 80



Table with plastic legs with HPL compact laminated tops 12 mm available in white and black. For indoor and outdoor use. Can be disassembled.

*\* Dark colors not recommended in direct sunlight.*

## 700 Air Table 80

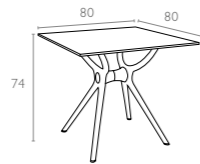

## Colors



White



Black



# Air Table I40



Table with plastic legs with HPL compact laminated tops 12 mm available in white and black. For indoor and outdoor use. Can be disassembled.

*\* Dark colors not recommended in direct sunlight.*

### 705 Air Table I40

---



#### Colors



White



Black





# Air Table 180



Table with plastic legs with HPL compact laminated tops 12 mm available in white and black. For indoor and outdoor use. Can be disassembled.

*\* Dark colors not recommended in direct sunlight.*

715 Air Table 180

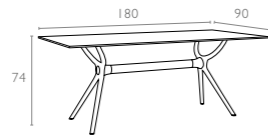

Colors



White



Black



# Sky Folding Legs



Sky folding leg is made of durable weather-resistant resin. Metallic frame will never unravel, rust or decay. It is UV protected which insures the colors will not fade. Can be disassembled and suitable for werzalit or HPL compact tops. For indoor and outdoor use.

## 118 Sky Folding Legs

Top min: 50x50 cm  
 Top max: 70x70 cm

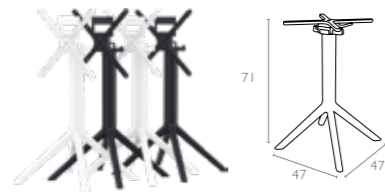

### Colors



White

Black



## Sky Legs



Sky leg is made of durable weather-resistant resin. Metallic frame will never unravel, rust or decay. It is UV protected which insures the colors will not fade. Can be disassembled and suitable for werzalit or HPL compact tops. For indoor and outdoor use.

## 107 Sky Legs

Top min : 70x70 cm  
Top max : 90x90 cm

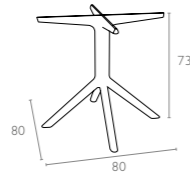

## Colors



White

Black

Dark Grey

Taupe





342 Max Legs Small

\*Top min. 70x70 cm, Top max. 90x90 cm

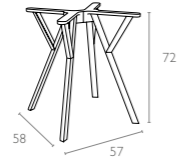

344 Max Legs Medium

\*Top min. 70x120 cm, Top max. 80x160 cm

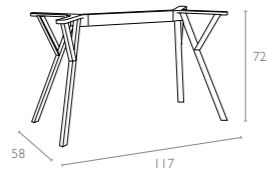

346 Max Legs XL

\*Top min 90x180 cm, Top max 100x200 cm

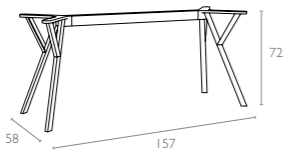

Max Legs are made up of polypropylene reinforced with glass fiber with the latest generation of air moulding thermoplastic injection. For indoor and outdoor use. Can be disassembled.

## Colors



White



Black

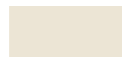

Taupe



## Air Legs



## 335 Air Legs Small

\* Top min. 70x70 cm, Top max. 90x90 cm

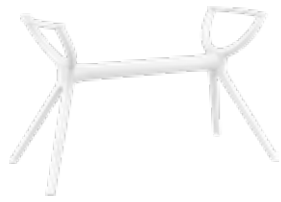
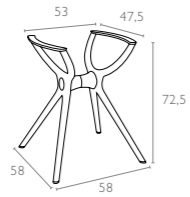

## 336 Air Legs Medium

\* Top min. 70x120 cm, Top max. 80x160 cm

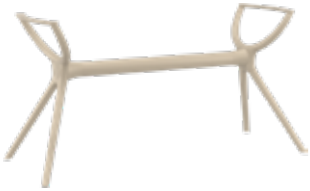
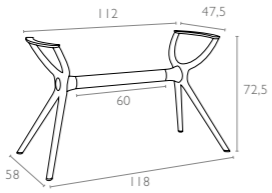

## 337 Air Legs XL

\* Top min 90x180 cm, Top max 100x200 cm

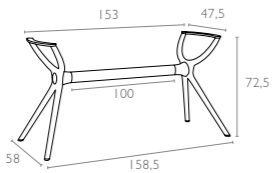

Air Legs are made up of polypropylene reinforced with glass fiber with the latest generation of air moulding thermoplastic injection. For indoor and outdoor use. Can be disassembled.

## Colors



White



Black

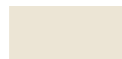

Taupe



# Octopus 60



Octopus table is made of durable weather-resistant resin. Metallic frame will never unravel, rust or decay. It is UV protected which insures the colors will not fade. Can be disassembled. For indoor and outdoor use.

## 160 Octopus 60



### Colors



## Octopus Bar



Octopus Bar table is made of durable weather-resistant resin. Metallic frame will never unravel, rust or decay. It is UV protected which insures the colors will not fade. Can be disassembled. For indoor and outdoor use.

## 161 Octopus Bar



## Colors



Black

Dark Grey

Taupe

White



# Sky Folding Bar Table 60



Sky folding bar table is made of durable weather-resistant resin. Metallic frame will never unravel, rust or decay. It is UV protected which insures the colors will not fade. Can be disassembled. For indoor and outdoor use.

116 Sky Folding Bar Table 60

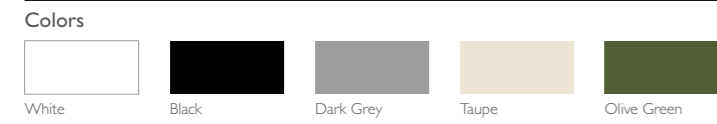
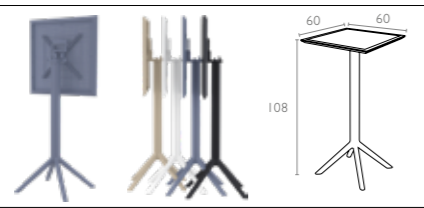



## Sky Folding Bar Table Ø60



Sky folding bar table is made of durable weather-resistant resin. Metallic frame will never unravel, rust or decay. It is UV protected which insures the colors will not fade. Can be disassembled. For indoor and outdoor use.

## 122 Sky Folding Bar Table Ø60



## Colors



# Ares 80



Ares 80 table is made of durable weather-resistant resin. Non-metallic frame will never unravel, rust or decay. It is UV protected which insures the colors will not fade. Can be disassembled. For indoor and outdoor use.

164 Ares 80

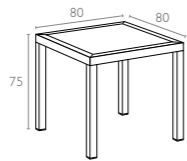

Colors

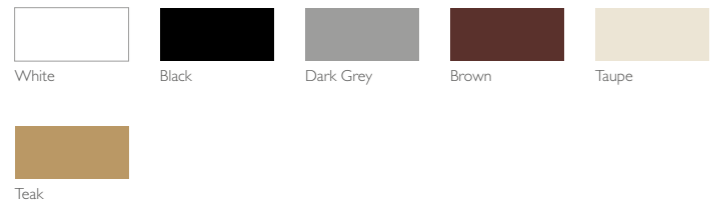

# Ares 140



Ares 140 table is made of durable weather-resistant resin. Non-metallic frame will never unravel, rust or decay. It is UV protected which insures the colors will not fade. Can be disassembled. For indoor and outdoor use.

186 Ares 140

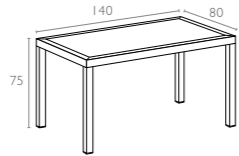

Colors

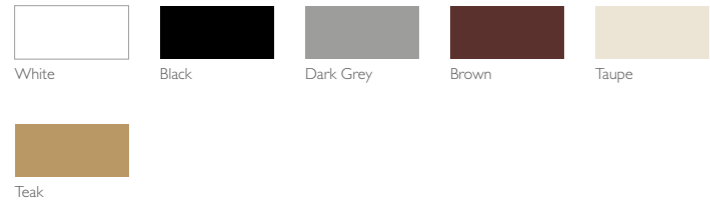



685 Maya 80

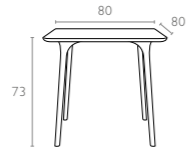

675 Maya 120



690 Maya 140

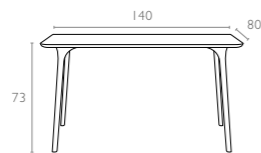

HPL compact laminated tops  
12 mm with the latest generation of  
air moulding thermoplastic legs.  
For indoor and outdoor use.  
Can be disassembled.

\* Dark colors not recommended in direct sunlight.



#### Colors



White



Black









500 - 510 - 520 Ice

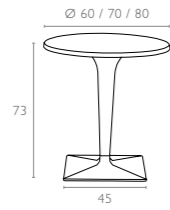

550 - 560 Ice

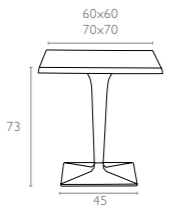

Table with clear transparent polycarbonate leg and painted aluminium base. Werzalit tops, resistant to outdoor use, available in white, black and silver grey. For indoor and outdoor use.



## Colors



White



Black



Silver Grey







# Ice Leg & Base



Clear transparent polycarbonate leg and painted aluminium base.  
For indoor and outdoor use.

310 Ice Leg & Base

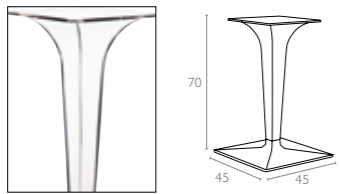

Made with **Makrolon**<sup>®</sup>  
The high-tech polycarbonate

Colors



Clear Transparent



# Mango



Stacking table with the latest generation of air moulding thermoplastic injection. For indoor and outdoor use.

800 Mango

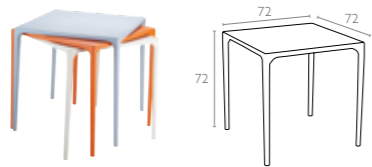

**Colors**



# Mango Alu



Stacking table with the latest generation of air moulding thermoplastic injection with legs in anodized aluminium. For indoor and outdoor use.

758 Mango Alu

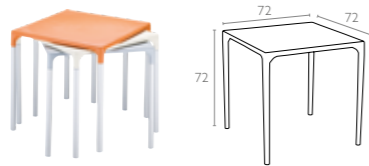

**Colors**



White

Beige

Orange

Silver Grey





Folding table with legs in anodized aluminium. Diameter 30 mm.  
Table top in recyclable polypropylene. For indoor and outdoor use.

## 770 Forza



## Colors

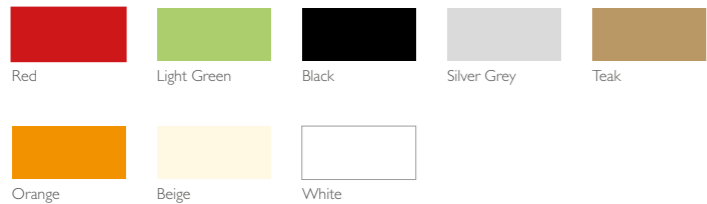
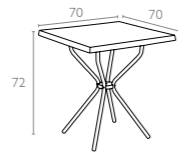



Table top in recyclable polypropylene, anodized aluminium legs.  
Diameter 25 mm. For indoor and outdoor use. Can be disassembled.

#### 750 Sortie



#### Colors



Black

Red

Light Green

Orange

Beige



White



## Poppy 80



Table top in recyclable polypropylene, anodized aluminium legs.  
Diameter 25 mm. For indoor and outdoor use. Can be disassembled.

720 Poppy 80

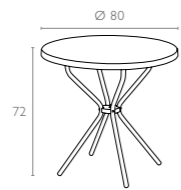

## Colors



Black

Red

Light Green

Orange

Beige



White





Table top in recyclable polypropylene, anodized aluminium legs.  
Diameter 25 mm. For indoor and outdoor use. Can be disassembled.

710 Elfo 70

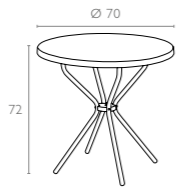

Colors



Black

Red

Light Green

Orange

Beige



White



# lighting

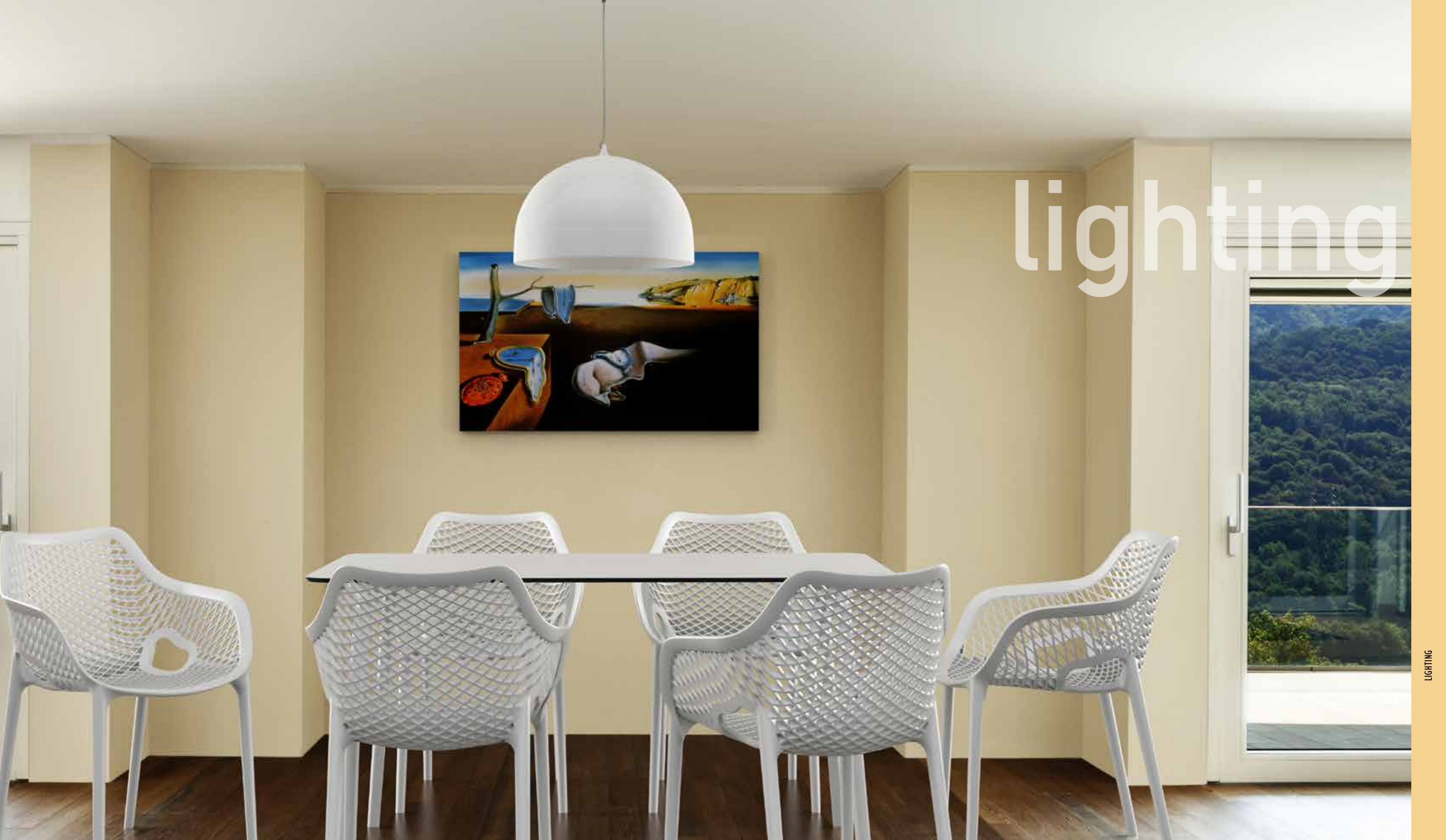



## Dodo



Suspension lamp in polycarbonate with 25W energy saving lamp. The diffuser can be removed without dismantling the electrical body, for an easy fitting and removal.

415 Dodo

CE

Made with  
**Makrolon®**  
The high-tech polycarbonate

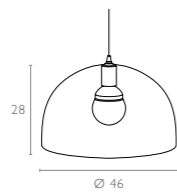

Colors





Suspension lamp in polycarbonate with 25W energy saving lamp. The diffuser can be removed without dismantling the electrical body, for an easy fitting and removal.

410 Nova

CE

Made with  
**Makrolon®**  
The high-tech polycarbonate

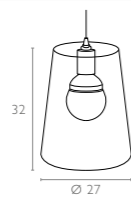

Colors



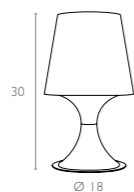

Table lamp made of transparent or coloured injected polycarbonate, with 40W lamp. Perfect gift idea.

420 Smart

CE

Made with  
**Makrolon®**  
The high-tech polycarbonate



Colors



Clear Transparent Black Transparent Violet Transparent Amber Transparent Pink Transparent



Blue Transparent Red Transparent Glossy White



index



## 282 PARIS

Paris stacking armchair is produced with a single injection of polypropylene reinforced with glass fiber obtained by means of the latest generation of air moulding technology with neutral tones. For indoor and outdoor use.



White



Dark Grey



Black



Taupe



Olive Green



Marsala

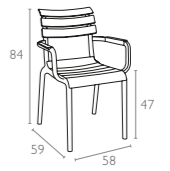

## 284 HELEN

Helen stacking chair is produced with a single injection of polypropylene reinforced with glass fiber obtained by means of the latest generation of air moulding technology with neutral tones. For indoor and outdoor use.



White



Dark Grey



Black



Taupe



Olive Green



Marsala

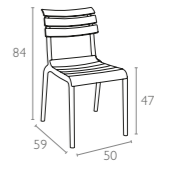

## 232 PACIFIC LOUNGE ARMCHAIR

Pacific stacking lounge armchair with Batyline fabric from Serge Ferrari is made from a weather-proof, UV-protected resin reinforced by glass fiber that stands up to summer showers and strong sun, making it the ideal, worry-free addition to your outdoor seating area. For domestic or commercial use.



White  
White



Dark Grey  
Black



Black  
Black



Taupe  
Taupe

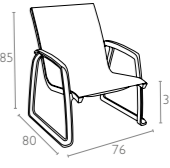

## 231 PACIFIC LOUNGE CHAIR

Pacific stacking lounge chair with Batyline fabric from Serge Ferrari is made from a weather-proof, UV-protected resin reinforced by glass fiber that stands up to summer showers and strong sun, making it the ideal, worry-free addition to your outdoor seating area. For domestic or commercial use.



White  
White



Dark Grey  
Black



Black  
Black



Taupe  
Taupe

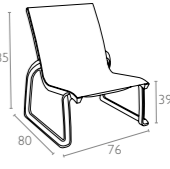

### 023 PACIFIC ARMCHAIR

Pacific armchair with Batyline fabric from Serge Ferrari is made from a weather-proof, UV-protected resin reinforced by glass fiber that stands up to summer showers and strong sun, making it the ideal, worry-free addition to your outdoor seating area. This versatile armchair pairs perfectly with the Pacific sunlounger, as well as a wide range of other outdoor tables. For domestic or commercial use.



White  
White



Dark Grey  
Black



Black  
Black



Taupe  
Taupe

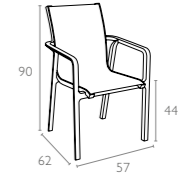

### 151 SKY PRO

Sky Pro stacking armchair is produced with a single injection of polypropylene reinforced with glass fiber obtained by means of the latest generation of air moulding technology with neutral tones. For indoor and outdoor use.



White



Dark Grey



Black



Taupe



Olive Green



Marsala

new color

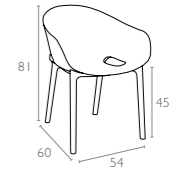

### 102 SKY

Sky armchair is produced with recyclable polypropylene seat and legs reinforced with glass fiber. For indoor and outdoor use. Can be disassembled.



White



Dark Grey



Black



Taupe



Red



Yellow

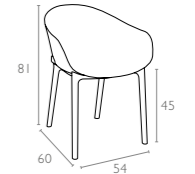

### 103 SKY LOUNGE

Sky lounge chair is produced with recyclable polypropylene seat and legs reinforced with glass fiber. For indoor and outdoor use. Can be disassembled.



White



Dark Grey



Black



Taupe



Red



Yellow

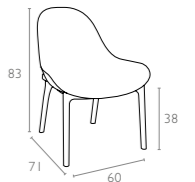
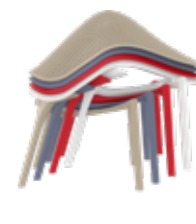

### 251 MARIE

Marie stacking chair is produced with a single injection of polypropylene reinforced with glass fiber obtained by means of the latest generation of air moulding technology with neutral tones. For indoor and outdoor use.



White



Black



Olive Green

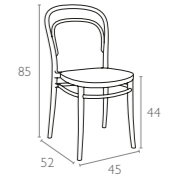

### 252 VICTOR

Victor stacking chair is produced with a single injection of polypropylene reinforced with glass fiber obtained by means of the latest generation of air moulding technology with neutral tones. For indoor and outdoor use.



White



Dark Grey



Black



Taupe



Olive Green

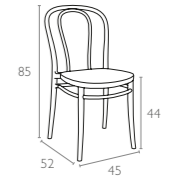

### 253 VICTOR XL

Victor XL stacking armchair is produced with a single injection of polypropylene reinforced with glass fiber obtained by means of the latest generation of air moulding technology with neutral tones. For indoor and outdoor use.



White



Dark Grey



Black



Taupe



Olive Green

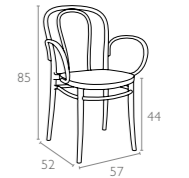

### 254 CROSS

Cross stacking chair is produced with a single injection of polypropylene reinforced with glass fiber obtained by means of the latest generation of air moulding technology with neutral tones. For indoor and outdoor use.



White



Dark Grey



Black



Taupe



Olive Green

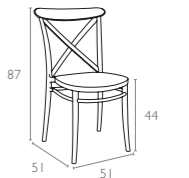

### 256 CROSS XL

Cross XL stacking armchair is produced with a single injection of polypropylene reinforced with glass fiber obtained by means of the latest generation of air moulding technology with neutral tones. For indoor and outdoor use.



White



Dark Grey



Black



Taupe



Olive Green

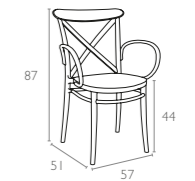

### 257 MARCEL

Marcel stacking chair is produced with a single injection of polypropylene reinforced with glass fiber obtained by means of the latest generation of air moulding technology with neutral tones. For indoor and outdoor use.



White



Dark Grey



Black



Taupe



Olive Green



Marsala

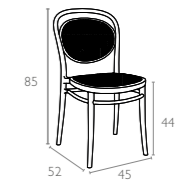

### 258 MARCEL XL

Marcel XL stacking armchair is produced with a single injection of polypropylene reinforced with glass fiber obtained by means of the latest generation of air moulding technology with neutral tones. For indoor and outdoor use.



White



Dark Grey



Black



Taupe



Olive Green



Marsala

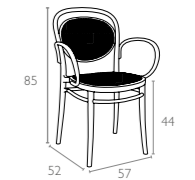

### 079 DREAM

Dream folding chair is produced with a single injection of polypropylene reinforced with glass fiber obtained by means of the latest generation of air moulding technology with neutral tones. For indoor and outdoor use.



White



Dark Grey



Black



Taupe



Red



Olive Green

designed by  
Frédéric Boonen  
**bds**

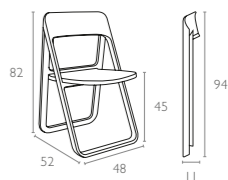



## 127 MONNA

Monna chair is produced with a single injection of polypropylene reinforced with glass fiber obtained by means of the latest generation of air moulding technology with neutral tones. For indoor and outdoor use.

CATAS  
TEST REPORT  
276554



White



Dark Grey



Black



Taupe



Red



Olive Green

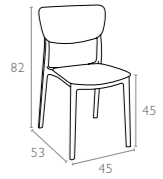

## 126 LISA

Lisa armchair is produced with a single injection of polypropylene reinforced with glass fiber obtained by means of the latest generation of air moulding technology with neutral tones. For indoor and outdoor use.

CATAS  
TEST REPORT  
276570



White



Dark Grey



Black



Taupe



Red



Olive Green

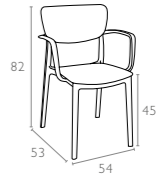

## 129 LUCY

Lucy chair is produced with a single injection of polypropylene reinforced with glass fiber obtained by means of the latest generation of air moulding technology with neutral tones. For indoor and outdoor use.

CATAS  
TEST REPORT  
276562



White



Dark Grey



Black



Taupe



Olive Green

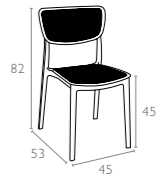

## 128 LOFT

Loft armchair is produced with a single injection of polypropylene reinforced with glass fiber obtained by means of the latest generation of air moulding technology with neutral tones. For indoor and outdoor use.

CATAS  
TEST REPORT  
276563



White



Dark Grey



Black



Taupe



Olive Green

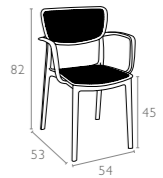

## 085 MILA

Mila armchair is produced with a single injection of polypropylene reinforced with glass fiber obtained by means of the latest generation of air moulding technology with neutral tones. For indoor and outdoor use.

**CATAS**  
TEST REPORT  
233341



White



Dark Grey



Black



Taupe



Red



Yellow

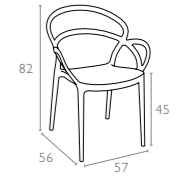

## 086 PIA

Pia chair is produced with a single injection of polypropylene reinforced with glass fiber obtained by means of the latest generation of air moulding technology with neutral tones. For indoor and outdoor use.

**CATAS**  
TEST REPORT  
233342



White



Dark Grey



Black



Taupe



Red



Yellow

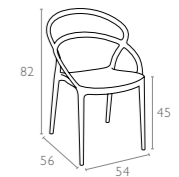

## 088 SUNSET

Sunset chair is produced with a single injection of polypropylene reinforced with glass fiber obtained by means of the latest generation of air moulding technology with neutral tones. For indoor and outdoor use.

**CATAS**  
TEST REPORT  
233343



White



Dark Grey



Black



Brown



Taupe

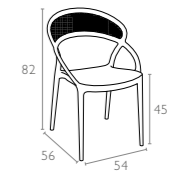

## 093 PLUS

Plus armchair is produced with a single injection of polypropylene reinforced with glass fiber obtained by means of the latest generation of air moulding technology with neutral tones. For indoor and outdoor use.

**CATAS**  
TEST REPORT  
235829



White



Black



Red

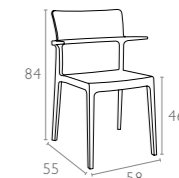

### 092 SNOW

Snow chair is produced with a single injection of polypropylene reinforced with glass fiber obtained by means of the latest generation of air moulding technology with neutral tones. For indoor and outdoor use.



White



Dark Grey



Black



Taupe



Red



Yellow



Olive Green



Marsala

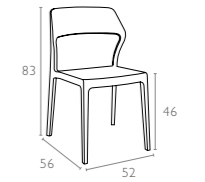

### 090 MOON

Stacking chair with the latest generation of air moulding thermoplastic injection. Seat in polypropylene reinforced with glass fiber, backrest in transparent polycarbonate. For indoor and outdoor use.



White Glossy White



White Amber Transparent



White Red Transparent



White Clear Transparent



Black Clear Transparent



Black Black Transparent



Black Amber Transparent



Black Red Transparent

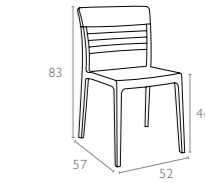

### 091 FLASH

Stacking chair with the latest generation of air moulding thermoplastic injection. Seat in polypropylene reinforced with glass fiber, backrest in transparent polycarbonate. For indoor and outdoor use.



White Glossy White



White Amber Transparent



White Red Transparent



White Clear Transparent



Black Clear Transparent



Black Black Transparent



Black Amber Transparent



Black Red Transparent

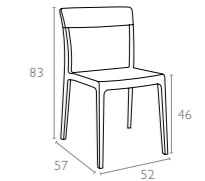

### 048 BLOOM

Bloom chair is produced with a single injection of polypropylene reinforced with glass fiber obtained by means of the latest generation of air moulding technology with neutral tones. For indoor and outdoor use.



White



Dark Grey



Silver Grey



Black



Taupe



Red



Yellow

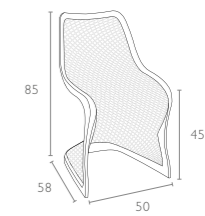

## 007 AIR XL

Air XL armchair is produced with a single injection of polypropylene reinforced with glass fiber obtained by means of the latest generation of air moulding technology with neutral tones. For indoor and outdoor use.

CATAS  
TEST REPORT  
182331



White



Orange



Dark Grey



Black



Taupe



Red



Tropical Green



Yellow

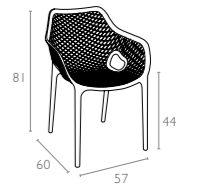

## 014 AIR

Air chair is produced with a single injection of polypropylene reinforced with glass fiber obtained by means of the latest generation of air moulding technology with neutral tones. For indoor and outdoor use.

CATAS  
TEST REPORT  
163635



White



Orange



Dark Grey



Black



Taupe



Red



Tropical Green



Yellow

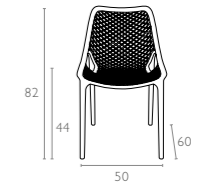

## 039 MIRANDA

Miranda chair is produced with a single injection of polypropylene reinforced with glass fiber obtained by means of the latest generation of air moulding technology with neutral tones. For indoor and outdoor use.

CATAS  
TEST REPORT  
201779



White



Dark Grey



Black



Brown



Taupe

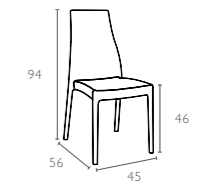

## 054 SOHO

Soho chair is produced with a single injection of polypropylene reinforced with glass fiber obtained by means of the latest generation of air moulding technology with neutral tones. For indoor and outdoor use.

CATAS  
TEST REPORT  
201772



White



Dark Grey



Black



Brown



Taupe



Red

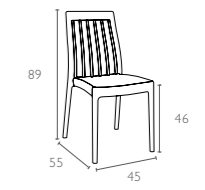

## 050 JOSEPHINE

Josephine wedding chair is produced with a single injection of polypropylene reinforced with glass fiber obtained by means of the latest generation of air moulding technology with neutral tones. For indoor and outdoor use.

**CATAS**  
TEST REPORT  
201775



White



Black

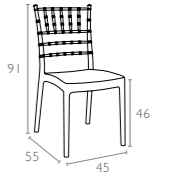

## 044 NAPOLEON

Napoleon wedding chair is produced with a single injection of polypropylene reinforced with glass fiber obtained by means of the latest generation of air moulding technology with neutral tones. For indoor and outdoor use.

**CATAS**  
TEST REPORT  
201775



White



Silver Grey



Black



Gold

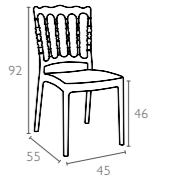

## 061 OPERA

Stacking wedding chair for indoor and outdoor use in clear or shiny polycarbonate. Scratch resistant, UV - resistant.

**CATAS**  
TEST REPORT  
226345

Made with  
**Makrolon®**  
The high-tech polycarbonate



Glossy White



Amber Transparent



Clear Transparent

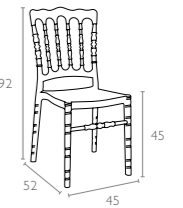

## 071 CHIAVARI

Stacking wedding chair for indoor and outdoor use in clear or shiny polycarbonate. Scratch resistant, UV - resistant.

**CATAS**  
TEST REPORT  
226347

Made with  
**Makrolon®**  
The high-tech polycarbonate



Glossy White



Amber Transparent



Clear Transparent

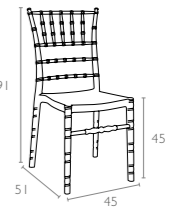

### 052 CRYSTAL

Stacking armchair for indoor and outdoor use in clear polycarbonate moulded with gas technology of the second generation. Scratch resistant, UV - resistant.



Glossy White



Clear Transparent



Smoke Grey Transparent



Black Transparent



Orange Transparent



Amber Transparent



Red Transparent

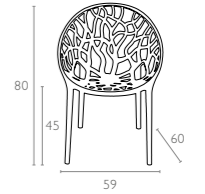
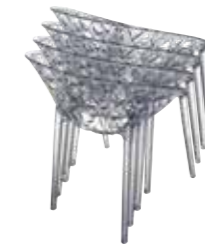

### 034 ELIZABETH

Stacking chair for indoor and outdoor use in shiny technopolymer PA6 nylon or clear polycarbonate. Scratch resistant, self - extinguish classification V2, UV - resistant.

\* On request with cushion.



Glossy White



Glossy Red



Glossy Black



Clear Transparent



Black Transparent



Amber Transparent



Pink Transparent



\* Black Transparent

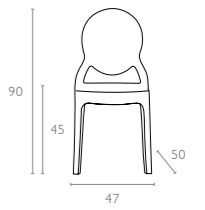

### 051 BABY ELIZABETH

Stacking children chair Baby Elizabeth for indoor and outdoor use in clear polycarbonate. Scratch resistant, UV - resistant.



Glossy White



Clear Transparent



Pink Transparent



Violet Transparent



Red Transparent



Blue Transparent

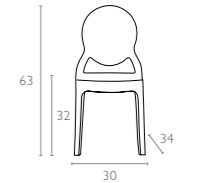

### 053 ARTHUR

Stacking armchair for indoor and outdoor use in shiny technopolymer PA6 nylon or clear polycarbonate. Scratch resistant, self - extinguish classification V2, UV - resistant.



Glossy White



Glossy Red



Glossy Black



Clear Transparent



Black Transparent



Amber Transparent

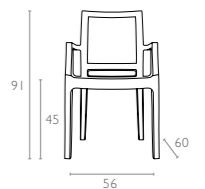

### 005 BO

Stacking chair for indoor and outdoor use in clear or shiny polycarbonate. Scratch resistant, UV - resistant.



Glossy White      Glossy Black      Clear Transparent

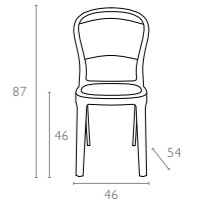
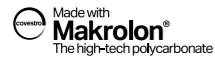

### 021 BEE

Stacking chair for indoor and outdoor use in clear or shiny polycarbonate. Scratch resistant, UV - resistant.



Glossy White      Glossy Black      Clear Transparent      Black Transparent      Amber Transparent      Red Transparent

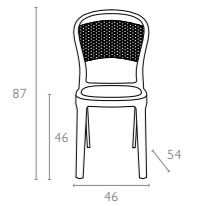
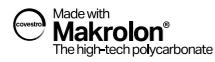

### 055 Miss BIBI

Stacking chair with the latest generation of air moulding thermoplastic injection. Seat in polypropylene reinforced with glass fiber, backrest in transparent polycarbonate. For indoor and outdoor use.



White Clear Transparent      White Amber Transparent      White Black Transparent      White Red Transparent      White Violet Transparent      Dark Grey Clear Transparent      Dark Grey Smoke Grey Transparent      Black Clear Transparent      Black Amber Transparent      Black Black Transparent

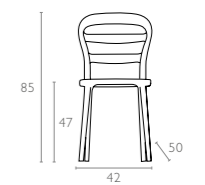

### 056 Mr BOBO

Stacking chair with the latest generation of air moulding thermoplastic injection. Seat in polypropylene reinforced with glass fiber, backrest in transparent polycarbonate. For indoor and outdoor use.



White Clear Transparent      White Amber Transparent      White Black Transparent      Dark Grey Clear Transparent      Dark Grey Smoke Grey Transparent      Black Clear Transparent      Black Black Transparent

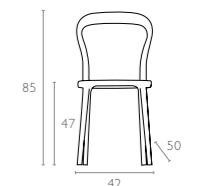

## 059 CARMEN

Stacking armchair with the latest generation of air moulding thermoplastic injection. Seat in polypropylene reinforced with glass fiber, backrest in transparent polycarbonate. For indoor and outdoor use.

CATAS  
TEST REPORT  
120254

Made with  
**Makrolon®**  
The high-tech polycarbonate



White  
Glossy White

White  
Clear  
Transparent

White  
Amber  
Transparent

White  
Black  
Transparent

White  
Red  
Transparent



White  
Violet  
Transparent

Black  
Clear  
Transparent

Black  
Black  
Transparent

Black  
Amber  
Transparent

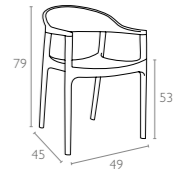

## 057 ALLEGRA

Recyclable polycarbonate main body. Legs frame in tubular chrome steel. Stackable. For indoor use.



Glossy  
White

Clear  
Transparent

Black  
Transparent

Amber  
Transparent

Red  
Transparent

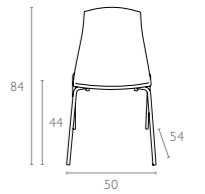

## 096 ALLEGRA-PP

Recyclable polycarbonate main body. Legs frame in polypropylene. For indoor and outdoor use. Can be disassembled.



White  
Glossy White

Black  
Black  
Transparent

Brown  
Glossy White

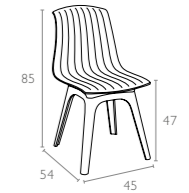

## 094 MIO-PP

Mio-PP chair is produced with recyclable polypropylene seat and legs reinforced with glass fiber. For indoor and outdoor use. Can be disassembled.



White  
White

Black  
Black

Brown  
White

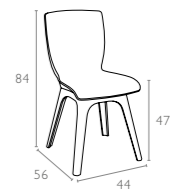



## 046 MIO

Stacking chair with recyclable polypropylene seat and backrest and painted steel legs. For indoor use.



White



Beige



Red



Orange



Black

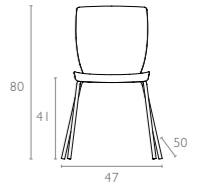

## 025 MAYA

Stacking chair with the latest generation of air moulding thermoplastic injection. For indoor and outdoor use.



White



Orange



Silver Grey



Black



Light Blue



Dark Grey



Tropical Green



Olive Green

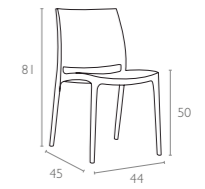

CATAS  
TEST REPORT  
73610

## 028 DIVA

Diva armchair is produced with a single injection of polypropylene reinforced with glass fiber obtained by means of the latest generation of air moulding technology with neutral tones. For indoor and outdoor use.



White



Orange



Silver Grey



Black



Light Blue



Dark Grey



Red



Tropical Green

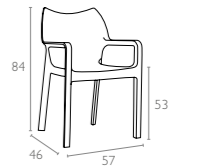

CATAS  
TEST REPORT  
101128

## 058 BOX

Recyclable polypropylene stacking armchair, strong and stable. Suitable for outdoor contract use.



White



Silver Grey



Dark Grey



Black



Red



Orange



Tropical Green

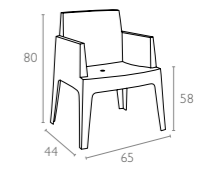

CATAS  
TEST REPORT  
117039

## 063 BOX SOFA

Recyclable polypropylene stackable sofa, very sturdy and stable. Suitable for outdoor contract use.



White

Silver Grey

Dark Grey

Black

Red

Orange

Tropical Green

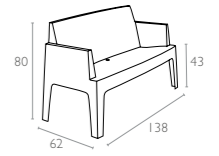

CATAS  
TEST REPORT  
152392



## 009 ARES

Ares chair is produced with a single injection of polypropylene reinforced with glass fiber obtained by means of the latest generation of air moulding technology with neutral tones. For indoor and outdoor use.



White

Taupe

Teak

Brown

Silver Grey

Dark Grey

Black

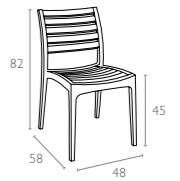

CATAS  
TEST REPORT  
163637



## 011 ARTEMIS

Artemis armchair is produced with a single injection of polypropylene reinforced with glass fiber obtained by means of the latest generation of air moulding technology with neutral tones. For indoor and outdoor use.



White

Taupe

Teak

Brown

Silver Grey

Dark Grey

Black

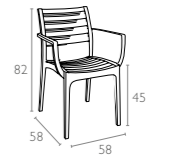

CATAS  
TEST REPORT  
163636



## 004 ARTEMIS XL

Artemis XL Lounge armchair is stackable and produced with a single injection of polypropylene reinforced with glass fiber, for indoor and outdoor use with or without cushion and non-slip feet. The Artemis collection also includes a coffee table, in various sizes, designed to match the styling silhouette of the chair to perfection.



White

Taupe

Silver Grey

Dark Grey

Black

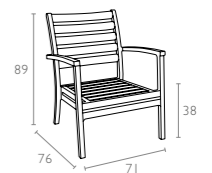

CATAS  
TEST REPORT  
184080



### 018 TIFFANY

Tiffany chair is produced with a single injection of polypropylene reinforced with glass fiber obtained by means of the latest generation of air moulding technology with neutral tones. Stackable. For indoor and outdoor use.



White



Orange



Silver Grey



Black



Light Blue



Dark Grey



Brown



Tropical Green

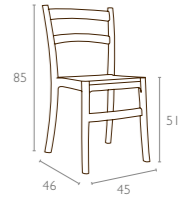

### 019 TIFFANY-S

Tiffany-S chair is produced with a single injection of polypropylene reinforced with glass fiber obtained by means of the latest generation of air moulding technology with neutral tones. Stackable. For indoor and outdoor use.



White



Light Blue



Dark Grey



Brown

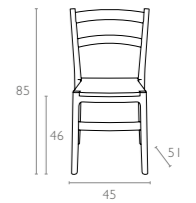

### 026 LUCCA

Stacking chair with the latest generation of air moulding thermoplastic injection. For indoor and outdoor use.



White



Orange



Silver Grey



Light Blue



Dark Grey



Tropical Green

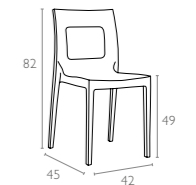

### 029 LUCCA-T

Stacking chair with the latest generation of air moulding thermoplastic injection. Back in transparent polycarbonate. For indoor and outdoor use.



White



Orange



Light Blue

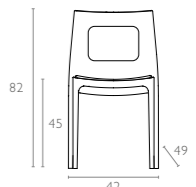

**047 DOLCE**

Stacking armchair with recyclable polypropylene seat and backrest and anodized aluminium legs. Diameter 25 mm. For indoor and outdoor use.



White



Beige



Red



Orange



Light Green



Dark Grey

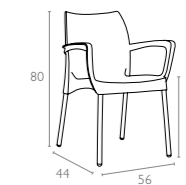

Black

**049 VITA**

Stacking chair with recyclable polypropylene seat and backrest and anodized aluminium legs. Diameter 25 mm. For indoor and outdoor use.



White



Beige



Red



Orange



Light Green



Dark Grey

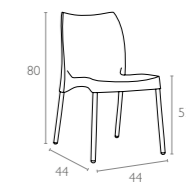

Black

**043 ROMEO**

Stacking armchair with recyclable polypropylene seat and backrest and anodized aluminium legs. Diameter 25 mm. For indoor and outdoor use.



White



Beige



Red



Orange



Light Green



Black

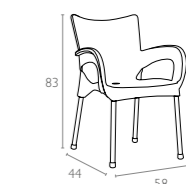

Blue

**045 JULIETTE**

Stacking chair with recyclable polypropylene seat and backrest and anodized aluminium legs. Diameter 25 mm. For indoor and outdoor use.



White



Beige



Red



Orange



Light Green



Black



Blue

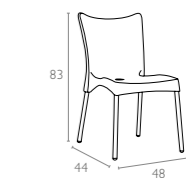

### 041 GALA

Stacking armchair in anodized aluminium with seat and back in recyclable polypropylene with latest generation of air moulding thermoplastic injection. Diameter 25 mm. For indoor and outdoor use.



White

Orange

Teak

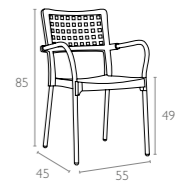

### 040 BELLA

Stacking armchair in anodized aluminium with seat and back in recyclable polypropylene with latest generation of air moulding thermoplastic injection. Diameter 25 mm. For indoor and outdoor use.



White

Orange

Teak

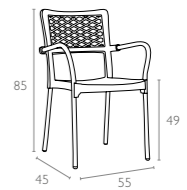

### 899 ARTEMIS XL SEAT CUSHION

5 cm thick seat cushion covered with polyester fabric and finished with piping. Cushion is specially designed for Artemis XL armchair.



White

Light Grey

Beige

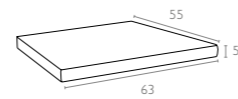

### 900 ARTEMIS XL BACKREST CUSHION

5 cm thick backrest cushion covered with polyester fabric and finished with piping. Cushion is specially designed for Artemis XL armchair.



White

Light Grey

Beige

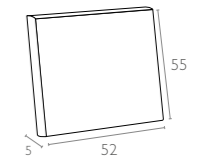

### 097 LINK

Link linking device in polypropylene to be fixed on the frame. Suitable for all round legs Ø 25mm.



Silver Grey

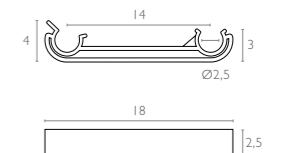

## 238 PACIFIC LOUNGE SET WITH ARMS

Pacific Lounge Set with arms is designed for easy self assembly, it is made of durable weather-resistant resin reinforced with glass fiber with Batyline fabric from Serge Ferrari. Non-metallic frame will never unravel, rust or decay. It is UV protected which insures the colors will not fade. For indoor and outdoor use. Can be purchased as set or separately.



White / White



Taupe / Taupe



Black / Black

Pacific Lounge Armchair  
2 pcs

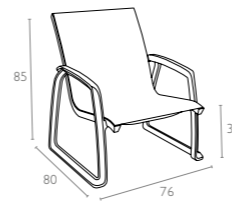

Pacific Lounge Sofa Armchair  
1 pcs

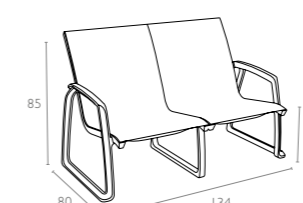

Sky Lounge Table  
1 pcs

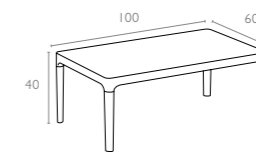

## 237 PACIFIC LOUNGE SET WITHOUT ARMS

Pacific Lounge Set without arms is designed for easy self assembly, it is made of durable weather-resistant resin reinforced with glass fiber with Batyline fabric from Serge Ferrari. Non-metallic frame will never unravel, rust or decay. It is UV protected which insures the colors will not fade. For indoor and outdoor use. Can be purchased as set or separately.



White / White



Taupe / Taupe



Black / Black

Pacific Lounge Chair  
2 pcs

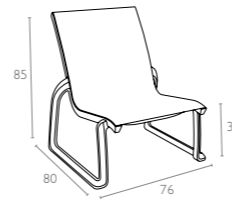

Pacific Lounge Sofa Chair  
1 pcs

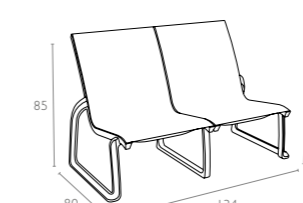

Sky Lounge Table  
1 pcs

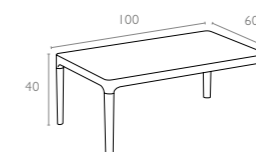

### 236 PACIFIC LOUNGE EXTENSION PART

With the Pacific Lounge extension part you can add as many seats as you want to extend your Pacific Lounge Sofa with Batyline fabric from Serge Ferrari.



White  
White

Black  
Black

Taupe  
Taupe

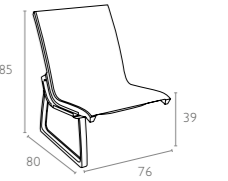

### 234 PACIFIC LOUNGE SOFA ARMCHAIR

Pacific Lounge sofa with arms designed for easy self assembly with Batyline fabric from Serge Ferrari is made from a weather-proof, UV-protected resin reinforced by glass fiber that stands up to summer showers and strong sun, making it the ideal, worry-free addition to your outdoor seating area. For domestic or commercial use.



White  
White

Black  
Black

Taupe  
Taupe

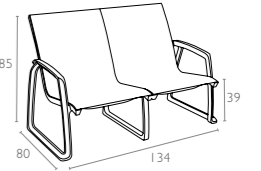

### 233 PACIFIC LOUNGE SOFA CHAIR

Pacific Lounge sofa without arms designed for easy self assembly with Batyline fabric from Serge Ferrari is made from a weather-proof, UV-protected resin reinforced by glass fiber that stands up to summer showers and strong sun, making it the ideal, worry-free addition to your outdoor seating area. For domestic or commercial use.



White  
White

Black  
Black

Taupe  
Taupe

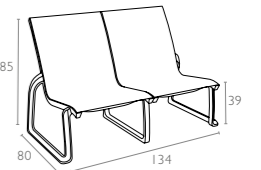

### 133 MYKONOS LOUNGE SET XL

Mykonos Lounge Set XL is designed for easy self assembly, it is made of durable weather-resistant resin reinforced with glass fiber. Non-metallic frame will never unravel, rust or decay. It is UV protected which insures the colors will not fade. Can be disassembled. For indoor and outdoor contract use.



White



Silver Grey



Taupe

Mykonos Lounge Armchair  
2 pcs

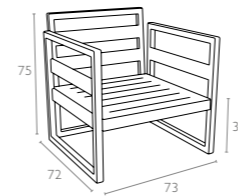

Mykonos Lounge Sofa XL  
1 pcs

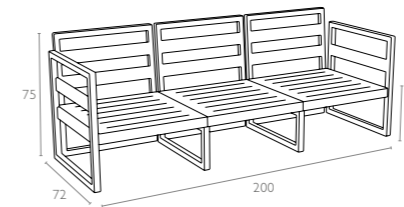

Mykonos Lounge Table XL  
1 pcs

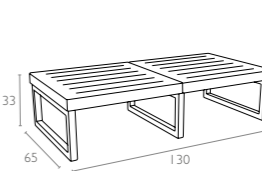

Mykonos Seat Cushion  
5 pcs

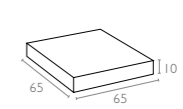

Mykonos Backrest Cushion  
5 pcs

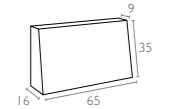

\* Can be purchased with or without cushions.



### 132 MYKONOS LOUNGE SET

Mykonos Lounge Set is designed for easy self assembly, it is made of durable weather-resistant resin reinforced with glass fiber. Non-metallic frame will never unravel, rust or decay. It is UV protected which insures the colors will not fade. Can be disassembled. For indoor and outdoor contract use.



White



Silver Grey



Taupe

Mykonos Lounge Armchair  
2 pcs

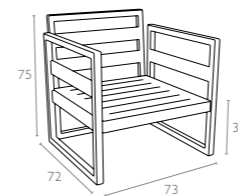

Mykonos Lounge Sofa  
1 pcs

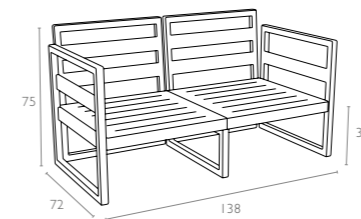

Mykonos Lounge Table  
1 pcs

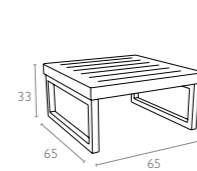

Mykonos Seat Cushion  
4 pcs

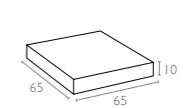

Mykonos Backrest Cushion  
4 pcs

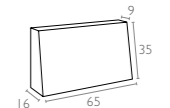

\* Can be purchased with or without cushions.





## 134 MYKONOS LOUNGE CORNER SET

Mykonos Lounge Corner Set is designed for easy self assembly, it is made of durable weather-resistant resin reinforced with glass fiber. Non-metallic frame will never unravel, rust or decay. It is UV protected which insures the colors will not fade. Can be disassembled. For indoor and outdoor contract use.



White



Taupe



Silver Grey



Mykonos Lounge Corner  
1 pcs

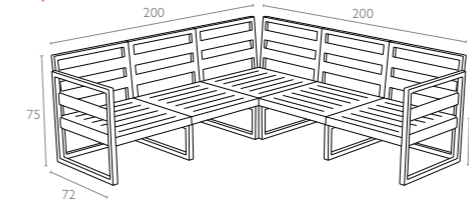

Mykonos Lounge Table  
1 pcs

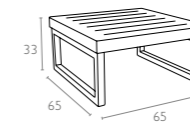

Mykonos Seat Cushion  
5 pcs

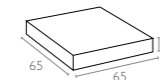

Mykonos Backrest Cushion  
5 pcs

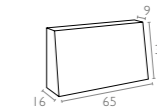

Mykonos Corner Cushion  
1 pcs

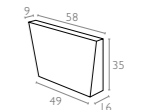

\* Can be purchased with or without cushions.



## 131 MYKONOS LOUNGE ARMCHAIR

Mykonos Lounge Armchair is designed for easy self assembly, it is made of durable weather-resistant resin reinforced with glass fiber. Non-metallic frame will never unravel, rust or decay. It is UV protected which insures the colors will not fade. Can be disassembled. For indoor and outdoor contract use.



White



Taupe



Silver Grey

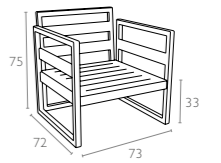

## 137 MYKONOS LOUNGE TABLE

Mykonos Lounge Table is made of durable weather-resistant resin. Non-metallic frame will never unravel, rust or decay. It is UV protected which insures the colors will not fade. Can be disassembled. For indoor and outdoor use.



White



Taupe



Silver Grey

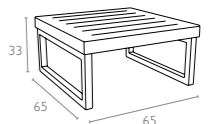

## 138 MYKONOS LOUNGE TABLE XL

Mykonos Lounge Table XL is made of durable weather-resistant resin. Non-metallic frame will never unravel, rust or decay. It is UV protected which insures the colors will not fade. Can be disassembled. For indoor and outdoor use.



White

Taupe

Silver Grey

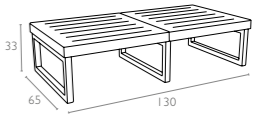

## 136 MYKONOS EXTENSION PART

With the extension part you can add as many seats as you want to extend your corner set.



White

Taupe

Silver Grey

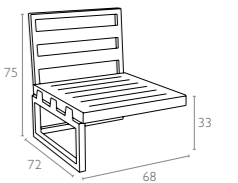

## 141 MYKONOS SEAT CUSHION

10 cm thick cushion covered with Eteisilk polyester fabric and finished with piping. Cushions are specially designed for Mykonos Lounge Set. Water resistant with UV.



Beige

Light Brown

Dark Grey

Black

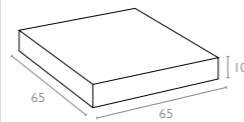

## 142 MYKONOS BACKREST CUSHION

10 cm thick cushion covered with Eteisilk polyester fabric and finished with piping. Cushions are specially designed for Mykonos Lounge Set. Water resistant with UV.



Beige

Light Brown

Dark Grey

Black

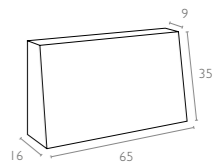

## 143 MYKONOS CORNER CUSHION

10 cm thick cushion covered with Eteisilk polyester fabric and finished with piping. Cushions are specially designed for Mykonos Lounge Set. Water resistant with UV.



Beige

Light Brown

Dark Grey

Black

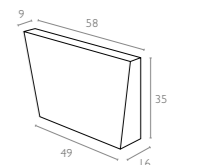

**etisilk**  
Outdoor Furniture Fabrics

**etisilk**  
Outdoor Furniture Fabrics

**etisilk**  
Outdoor Furniture Fabrics

### 087 SLIM

Slim sunlounger is stackable and comes with hidden wheels and anti-slippery rubbers. It is made of durable weather-resistant resin. Non metallic frame will never unravel, rust or decay. It is UV protected which insures the colors will not fade. For outdoor use.



White

Black

Dark Grey

Taupe

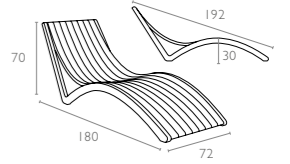

### 708 TROPIC

Tropic sunlounger with legs in resin reinforced with glass fiber combined with lacquered aluminium structure. Cover in breathable synthetic replaceable fabric, back reclining in 5 positions, with non-slip feet and small wheels. Two materials combined together to make a very resistant, functional light-weight and stackable sunlounger.



White  
White

White  
Taupe

Dark Grey  
Black

Black  
Black

Taupe  
Taupe

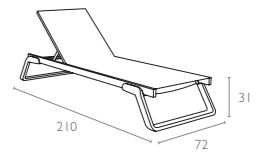

### 709 TROPIC ARM

Armrest for Tropic sunlounger. Arms in resin reinforced with glass fiber. Can be fixed onto the sunlounger frame with the provided screws.



White

Dark Grey

Black

Taupe

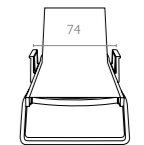
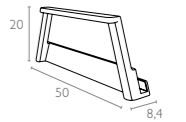

### 089 PACIFIC

Sunlounger without arms, tubular frame in resin reinforced with glass fiber and cover in breathable synthetic fabric (replaceable). Stackable, back reclining in 5 positions, with non-slip feet and small wheels.



White  
White

White  
Taupe

White  
Turquoise

White  
Blue

Dark Grey  
Black

Black  
Black

Taupe  
Taupe

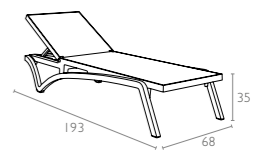

### 144 SLIM CUSHION

3 cm thick cushion covered with Etisilk polyester fabric and finished with piping. Cushions are specially designed for Slim sunlounger Water resistant with UV.

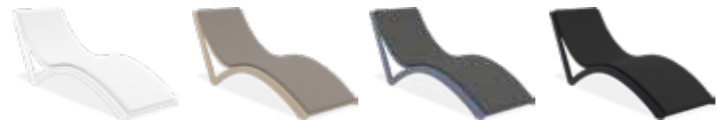

White Light Brown Dark Grey Black



### 148 SLIM PILLOW CUSHION

5 cm thick pillow cushion covered with Etisilk polyester fabric and finished with piping. Cushions are specially designed for Slim sunlounger Water resistant with UV.

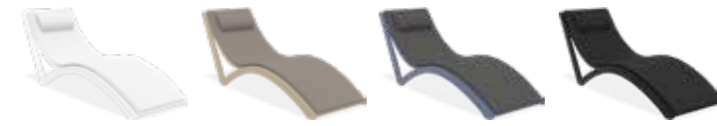

White Light Brown Dark Grey Black

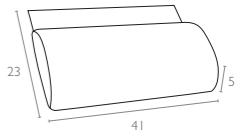

### 286 TOM 45

Tom stacking stool h.45 cm is produced with a single injection of polypropylene reinforced with glass fiber obtained by means of the latest generation of air moulding technology with neutral tones. For indoor and outdoor use.



White



Dark Grey



Black



Taupe



Olive Green



Marsala

new color

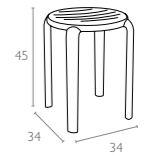

### 287 TOM BAR 65

Tom bar stool h.65 cm is produced with a single injection of polypropylene reinforced with glass fiber obtained by means of the latest generation of air moulding technology with neutral tones. For indoor and outdoor use.



White



Dark Grey



Black



Taupe



Olive Green



Marsala

new color

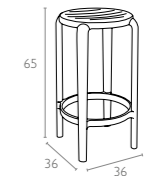

### 288 TOM BAR 75

Tom bar stool h.75 cm is produced with a single injection of polypropylene reinforced with glass fiber obtained by means of the latest generation of air moulding technology with neutral tones. For indoor and outdoor use.



White



Dark Grey



Black



Taupe



Olive Green



Marsala

new color

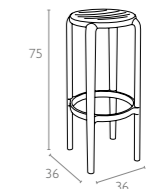

## 262 VICTOR BAR 75

Victor bar stool h.75 cm is produced with a single injection of polypropylene reinforced with glass fiber obtained by means of the latest generation of air moulding technology with neutral tones. For indoor and outdoor use.

**CATAS**  
TEST REPORT  
294882



White



Dark Grey



Black



Taupe



Olive Green

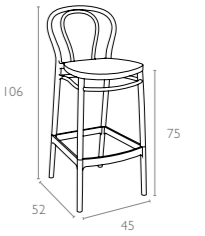

## 261 VICTOR BAR 65

Victor bar stool h.65 cm is produced with a single injection of polypropylene reinforced with glass fiber obtained by means of the latest generation of air moulding technology with neutral tones. For indoor and outdoor use.

**CATAS**  
TEST REPORT  
294882



White



Dark Grey



Black



Taupe



Olive Green

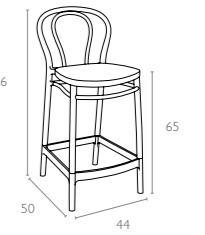

## 266 CROSS BAR 75

Cross bar stool h.75 cm is produced with a single injection of polypropylene reinforced with glass fiber obtained by means of the latest generation of air moulding technology with neutral tones. For indoor and outdoor use.

**CATAS**  
TEST REPORT  
294881



White



Dark Grey



Black



Taupe



Olive Green

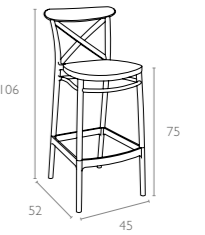

## 264 CROSS BAR 65

Cross bar stool h.65 cm is produced with a single injection of polypropylene reinforced with glass fiber obtained by means of the latest generation of air moulding technology with neutral tones. For indoor and outdoor use.

**CATAS**  
TEST REPORT  
294881



White



Dark Grey



Black



Taupe



Olive Green

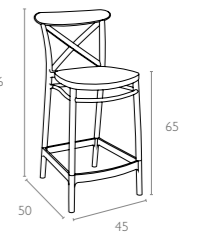

## 269 MARCEL BAR 75

Marcel bar stool h.75 cm is produced with a single injection of polypropylene reinforced with glass fiber obtained by means of the latest generation of air moulding technology with neutral tones. For indoor and outdoor use.

**CATAS**  
TEST REPORT  
294883



White



Dark Grey



Black



Taupe



Olive Green



Marsala

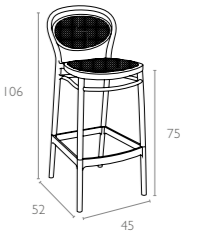

## 268 MARCEL BAR 65

Marcel bar stool h.65 cm is produced with a single injection of polypropylene reinforced with glass fiber obtained by means of the latest generation of air moulding technology with neutral tones. For indoor and outdoor use.

**CATAS**  
TEST REPORT  
294883



White



Dark Grey



Black



Taupe



Olive Green



Marsala

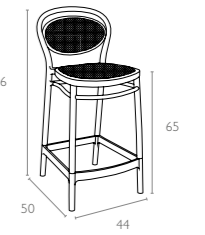

## 099 MAYA BAR 75

Maya stacking bar stool h.75 cm is produced with a single injection of polypropylene reinforced with glass fiber obtained by means of the latest generation of air moulding technology with neutral tones. For indoor and outdoor use.

**CATAS**  
TEST REPORT  
236234



White



Dark Grey



Black



Taupe



Olive Green

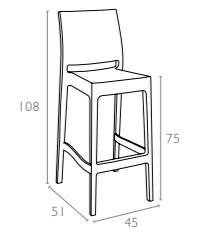

## 100 MAYA BAR 65

Maya stacking bar stool h.65 cm is produced with a single injection of polypropylene reinforced with glass fiber obtained by means of the latest generation of air moulding technology with neutral tones. For indoor and outdoor use.

**CATAS**  
TEST REPORT  
236234



White



Dark Grey



Black



Taupe



Olive Green

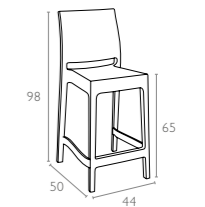

## 101 ARES BAR 75

Ares stacking bar stool h.75 cm is produced with a single injection of polypropylene reinforced with glass fiber obtained by means of the latest generation of air moulding technology with neutral tones. For indoor and outdoor use.

**CATAS**  
TEST REPORT  
236235



White



Dark Grey



Black



Brown



Taupe

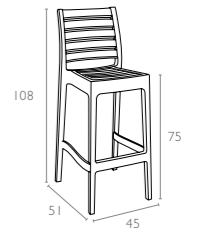

## 073 OPERA BAR 75

Stacking wedding bar stool h.75 cm for indoor and outdoor use in clear or shiny polycarbonate. Scratch resistant, UV - resistant.

**CATAS**  
TEST REPORT  
226344

Made with  
**Makrolon®**  
The high-tech polycarbonate



Glossy White



Amber Transparent



Clear Transparent

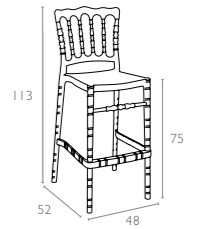

## 074 OPERA BAR 65

Stacking wedding bar stool h.65 cm for indoor and outdoor use in clear or shiny polycarbonate. Scratch resistant, UV - resistant.

**CATAS**  
TEST REPORT  
226344

Made with  
**Makrolon®**  
The high-tech polycarbonate



Glossy White



Amber Transparent



Clear Transparent

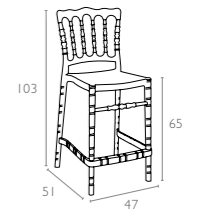

## 083 CHIAVARI BAR 75

Stacking wedding bar stool h.75 cm for indoor and outdoor use in clear or shiny polycarbonate. Scratch resistant, UV - resistant.

**CATAS**  
TEST REPORT  
226346

Made with  
**Makrolon®**  
The high-tech polycarbonate



Glossy White



Amber Transparent



Clear Transparent

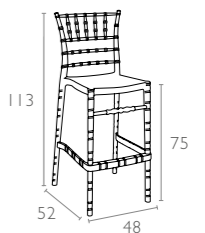

### 084 CHIAVARI BAR 65

Stacking wedding bar stool h.65 cm for indoor and outdoor use in clear or shiny polycarbonate. Scratch resistant, UV - resistant.



Glossy White



Amber Transparent



Clear Transparent

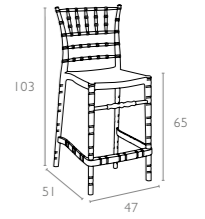
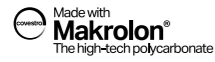

### 037 FOX 75

Stacking bar stool h.75 cm for indoor and outdoor use in shiny technopolymer PA6 nylon or clear polycarbonate. Scratch resistant, self - extinguish classification V2, UV - resistant.



Glossy White



Glossy Red



Clear Transparent



Smoke Grey Transparent



Amber Transparent



Black Transparent

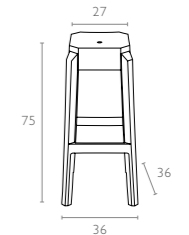

### 036 FOX 65

Stacking bar stool h.65 cm for indoor and outdoor use in shiny technopolymer PA6 nylon or clear polycarbonate. Scratch resistant, self - extinguish classification V2, UV - resistant.



Glossy White



Glossy Red



Clear Transparent



Black Transparent

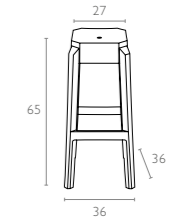
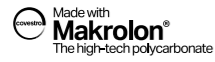

### 068 AIR BAR 75

Air Bar stool h.75 cm is produced with a single injection of polypropylene reinforced with glass fiber obtained by means of the latest generation of air moulding technology with neutral tones. For indoor and outdoor use.



White



Orange



Dark Grey



Black



Taupe



Red



Tropical Green

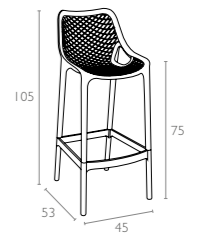



## 067 AIR BAR 65

Air Bar stool h.65 cm is produced with a single injection of polypropylene reinforced with glass fiber obtained by means of the latest generation of air moulding technology with neutral tones. For indoor and outdoor use.

CATAS  
TEST REPORT  
184081



White



Orange



Dark Grey



Black



Taupe



Red



Tropical Green

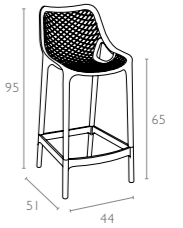

## 042 ARIA

Revolving stool with adjustable height with gas piston. Base and column in stainless steel. Seat in recyclable polycarbonate. For indoor use.

Made with  
**Makrolon**<sup>®</sup>  
The high-tech polycarbonate



Glossy White



Clear Transparent



Black Transparent



Red Transparent



Amber Transparent

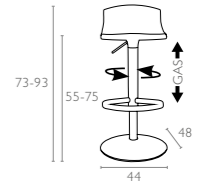

## 035 GIO 75

Stacking bar stool with recyclable polypropylene seat and backrest and square anodized aluminium legs. Diameter 25x25 mm. For indoor and outdoor use.



White



Beige



Red



Orange



Light Green



Black

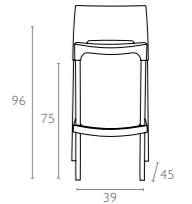

## 065 QUEEN

Stacking side table for indoor and outdoor use in clear polycarbonate. UV - resistant.

Made with  
**Makrolon**<sup>®</sup>  
The high-tech polycarbonate



Glossy White



Clear Transparent



Black Transparent



Amber Transparent

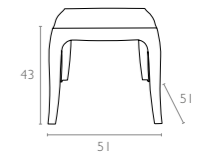

### 109 SKY SIDE TABLE

Sky Side Table is made of durable weather-resistant resin. Non-metallic frame will never unravel, rust or decay. It is UV protected which insures the colors will not fade. Can be disassembled. For indoor and outdoor use.



White



Dark Grey



Black



Taupe



Red



Yellow

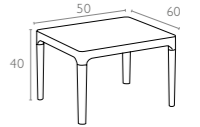

### 104 SKY LOUNGE TABLE

Sky Table is made of durable weather-resistant resin. Metallic frame will never unravel, rust or decay. It is UV protected which insures the colors will not fade. Can be disassembled. For indoor and outdoor use.



White



Dark Grey



Black



Taupe



Red



Yellow

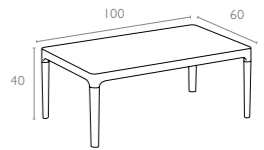

### 064 BOX TABLE

Stacking table in recyclable polypropylene. For indoor and outdoor use.



White



Silver Grey



Dark Grey



Black



Red



Orange



Tropical Green

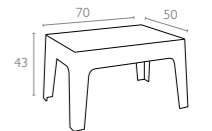

### 066 OCEAN SIDE TABLE

Ocean Side Table is made of durable weather-resistant resin. Non-metallic frame will never unravel, rust or decay. It is UV protected which insures the colors will not fade. Can be disassembled. For indoor and outdoor use.



White



Taupe



Silver Grey



Dark Grey



Black

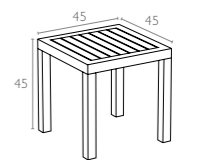

## 069 OCEAN TABLE

Ocean Lounge Table is made of durable weather-resistant resin. Non-metallic frame will never unravel, rust or decay. It is UV protected which insures the colors will not fade. Can be disassembled. For indoor and outdoor use.



White



Taupe



Silver Grey



Dark Grey



Black

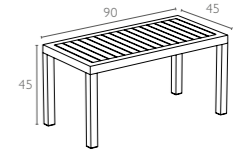

## 762 ATLANTIC TABLE 140/210

Extendible table from 140 to 210 cm in polypropylene with aluminium frame. Easily expandable, giving you a choice of two size options. Smart extending mechanism makes it easy to adjust the table to your preferred size. For indoor and outdoor use with UV protection.

100x140 / 100x210 cm

CATAS  
TEST REPORT



White



Taupe



Black

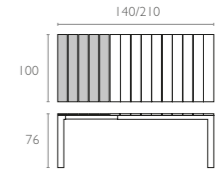

## 764 ATLANTIC TABLE 210/280

Extendible table from 210 to 280 cm in polypropylene with aluminium frame. Easily expandable, giving you a choice of two size options. Smart extending mechanism makes it easy to adjust the table to your preferred size. For indoor and outdoor use with UV protection.

100x210 / 100x280 cm

CATAS  
TEST REPORT



White



Taupe



Black

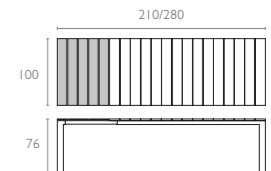

## 772 VEGAS TABLE

Extendible table from 100 to 140 cm in polypropylene reinforced with glass fiber. Easily expandable, giving you a choice of two size options. Smart extending mechanism makes it easy to adjust the table to your preferred size. For indoor and outdoor use with UV protection.

100x100 / 100x140 cm

CATAS  
TEST REPORT  
253099



White



Taupe



Dark Grey



Black

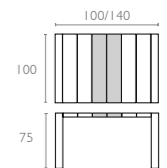

### 774 VEGAS TABLE MEDIUM

Extendible table from 180 to 220 cm in polypropylene reinforced with glass fiber. Easily expandable, giving you a choice of two size options. Smart extending mechanism makes it easy to adjust the table to your preferred size. For indoor and outdoor use with UV protection.

100x180 / 100x220 cm



White



Taupe



Dark Grey



Black

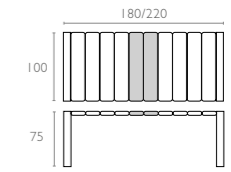

### 776 VEGAS TABLE XL

Extendible table from 260 to 300 cm in polypropylene reinforced with glass fiber. Easily expandable, giving you a choice of two size options. Smart extending mechanism makes it easy to adjust the table to your preferred size. For indoor and outdoor use with UV protection.

100x260 / 100x300 cm



White



Taupe



Dark Grey



Black

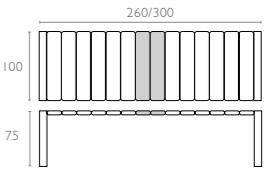

### 782 VEGAS BAR 100

Extendible bar table from 100 to 140 cm in polypropylene reinforced with glass fiber. Easily expandable, giving you a choice of two size options. Smart extending mechanism makes it easy to adjust the bar table to your preferred size. For indoor and outdoor use with UV protection.

100x100 / 100x140 cm



White



Taupe



Dark Grey



Black

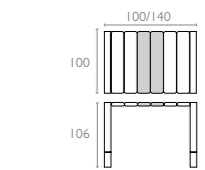

### 114 SKY FOLDING TABLE 60

Sky folding table is made of durable weather-resistant resin. Metallic frame will never unravel, rust or decay. It is UV protected which insures the colors will not fade. Can be disassembled. For indoor and outdoor use.

60x60 cm



White



Taupe



Dark Grey



Black



Olive Green

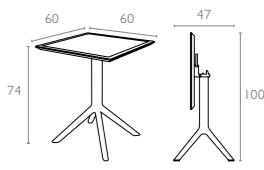

## 121 SKY FOLDING TABLE Ø60

Sky folding table is made of durable weather-resistant resin. Metallic frame will never unravel, rust or decay. It is UV protected which insures the colors will not fade. Can be disassembled. For indoor and outdoor use.

Ø 60 cm



White



Taupe



Dark Grey



Black



Olive Green

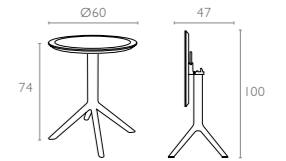

## 108 SKY TABLE 70

Sky Table is made of durable weather-resistant resin. Metallic frame will never unravel, rust or decay. It is UV protected which insures the colors will not fade. Can be disassembled. For indoor and outdoor use.

70x70 cm

**CATAS**  
TEST REPORT  
336570



White



Taupe



Dark Grey



Black



Olive Green

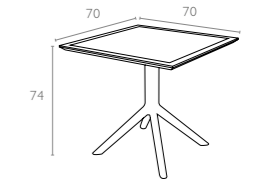

## 106 SKY TABLE 80

Sky Table is made of durable weather-resistant resin. Metallic frame will never unravel, rust or decay. It is UV protected which insures the colors will not fade. Can be disassembled. For indoor and outdoor use.

80x80 cm



White



Taupe



Dark Grey



Black



Olive Green

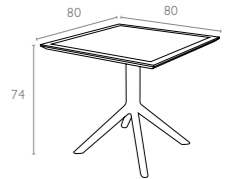

## 124 SKY TABLE Ø105

Sky Table is made of durable weather-resistant resin. Metallic frame will never unravel, rust or decay. It is UV protected which insures the colors will not fade. Can be disassembled. For indoor and outdoor use.

Ø 105 cm



White



Taupe



Dark Grey



Black



Olive Green

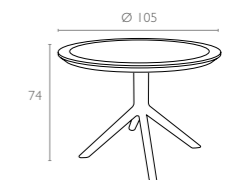

### 742 MAX TABLE 70

Table with plastic legs with HPL compact laminated tops 12 mm available in white and black. For indoor and outdoor use. Can be disassembled.

*\* Dark colors not recommended in direct sunlight.*

70x70 cm



White



Black

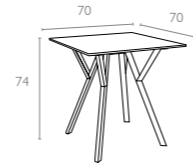

### 744 MAX TABLE Ø90

Table with plastic legs with HPL compact laminated tops 12 mm available in white and black. For indoor and outdoor use. Can be disassembled.

*\* Dark colors not recommended in direct sunlight.*

Ø 90 cm



White



Black

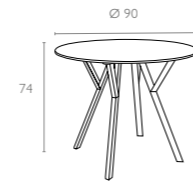

### 342 MAX LEGS SMALL

Max Legs are made up of polypropylene reinforced with glass fiber with the latest generation of air moulding thermoplastic injection. For indoor and outdoor use. Can be disassembled.



White



Black



Taupe

*\* Top min. 70x70 cm, Top max. 90x90 cm*

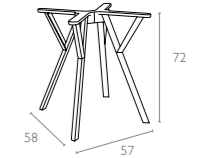

### 746 MAX TABLE 140

Table with plastic legs with HPL compact laminated tops 12 mm available in white and black. For indoor and outdoor use. Can be disassembled.

*\* Dark colors not recommended in direct sunlight.*

80x140 cm



White



Black



### 344 MAX LEGS MEDIUM

Max Legs are made up of polypropylene reinforced with glass fiber with the latest generation of air moulding thermoplastic injection. For indoor and outdoor use. Can be disassembled.



White



Black



Taupe

*\* Top min. 70x120 cm, Top max. 80x160 cm*

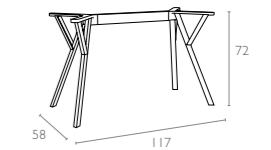

### 748 MAX TABLE 180

Table with plastic legs with HPL compact laminated tops 12 mm available in white and black. For indoor and outdoor use. Can be disassembled.

*\* Dark colors not recommended in direct sunlight.*

90x180 cm



White



Black



### 346 MAX LEGS XL

Max Legs are made up of polypropylene reinforced with glass fiber with the latest generation of air moulding thermoplastic injection. For indoor and outdoor use. Can be disassembled.



White



Black



Taupe

*\* Top min 90x180 cm, Top max 100x200 cm*

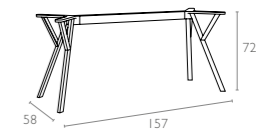

### 700 AIR TABLE 80

Table with plastic legs with HPL compact laminated tops 12 mm available in white and black. For indoor and outdoor use. Can be disassembled.

*\* Dark colors not recommended in direct sunlight.*

80x80 cm



White



Black

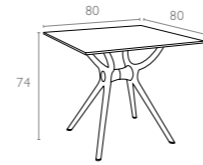

### 335 AIR LEGS SMALL

Air Legs are made up of polypropylene reinforced with glass fiber with the latest generation of air moulding thermoplastic injection. For indoor and outdoor use. Can be disassembled.



White



Black



Taupe

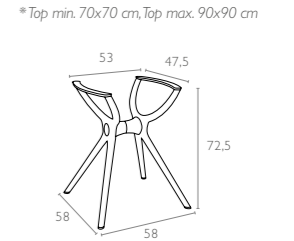

### 705 AIR TABLE 140

Table with plastic legs with HPL compact laminated tops 12 mm available in white and black. For indoor and outdoor use. Can be disassembled.

*\* Dark colors not recommended in direct sunlight.*

80x140 cm



White



Black

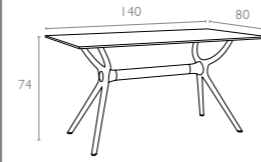

### 336 AIR LEGS MEDIUM

Air Legs are made up of polypropylene reinforced with glass fiber with the latest generation of air moulding thermoplastic injection. For indoor and outdoor use. Can be disassembled.



White



Black

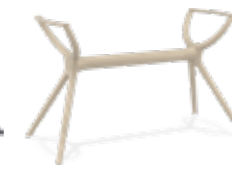

Taupe

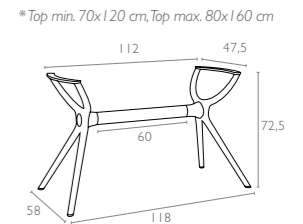

### 715 AIR TABLE 180

Table with plastic legs with HPL compact laminated tops 12 mm available in white and black. For indoor and outdoor use. Can be disassembled.

*\* Dark colors not recommended in direct sunlight.*

90x180 cm



White



Black

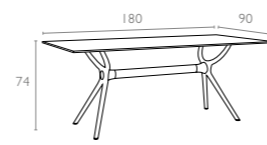

### 337 AIR LEGS XL

Air Legs are made up of polypropylene reinforced with glass fiber with the latest generation of air moulding thermoplastic injection. For indoor and outdoor use. Can be disassembled.

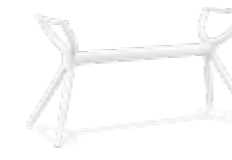

White



Black

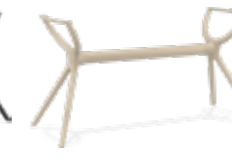

Taupe

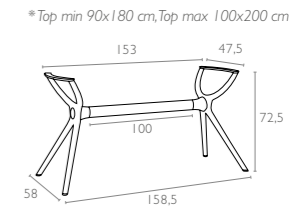

### 118 SKY FOLDING LEGS

Sky folding leg is made of durable weather-resistant resin. Metallic frame will never unravel, rust or decay. It is UV protected which insures the colors will not fade. Can be disassembled and suitable for werzalit or HPL compact tops. For indoor and outdoor use.



White



Black

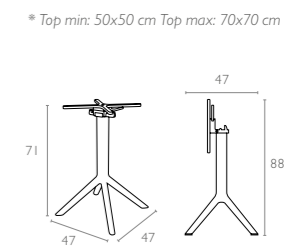

### 107 SKY LEGS

Sky leg is made of durable weather-resistant resin. Metallic frame will never unravel, rust or decay. It is UV protected which insures the colors will not fade. Can be disassembled and suitable for werzalit or HPL compact tops. For indoor and outdoor use.



White



Taupe



Dark Grey



Black

\* Top min: 70x70 cm Top max: 90x90 cm

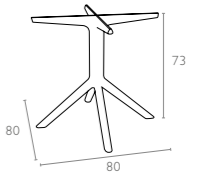

### 160 OCTOPUS 60

Octopus Table is made of durable weather-resistant resin. Metallic frame will never unravel, rust or decay. It is UV protected which insures the colors will not fade. Can be disassembled. For indoor and outdoor use.



White



Taupe



Silver Grey



Dark Grey



Black



Yellow

Ø 60 cm



### 161 OCTOPUS BAR

Octopus Bar Table is made of durable weather-resistant resin. Metallic frame will never unravel, rust or decay. It is UV protected which insures the colors will not fade. Can be disassembled. For indoor and outdoor use.



White



Taupe



Dark Grey



Black

Ø 60 cm

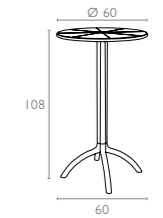

### 116 SKY FOLDING BAR TABLE 60

Sky folding bar table is made of durable weather-resistant resin. Metallic frame will never unravel, rust or decay. It is UV protected which insures the colors will not fade. Can be disassembled. For indoor and outdoor use.

60x60 cm



White



Taupe



Dark Grey



Black



Olive Green

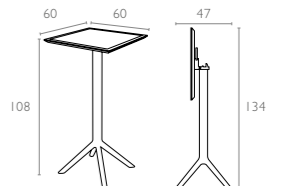



### 122 SKY FOLDING BAR TABLE Ø60

Sky folding bar table is made of durable weather-resistant resin. Metallic frame will never unravel, rust or decay. It is UV protected which insures the colors will not fade. Can be disassembled. For indoor and outdoor use.

Ø 60 cm



White



Taupe



Dark Grey



Black



Olive Green

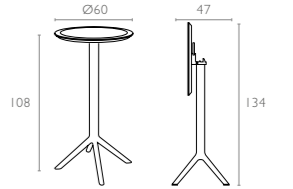

### 164 ARES 80

Ares 80 Table is made of durable weather-resistant resin. Non-metallic frame will never unravel, rust or decay. It is UV protected which insures the colors will not fade. Can be disassembled. For indoor and outdoor use.

80x80 cm



White



Taupe



Teak



Brown



Dark Grey



Black

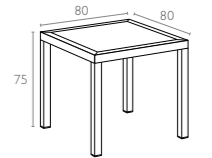

### 186 ARES 140

Ares 140 Table is made of durable weather-resistant resin. Non-metallic frame will never unravel, rust or decay. It is UV protected which insures the colors will not fade. Can be disassembled. For indoor and outdoor use.

80x140 cm



White



Taupe



Teak



Brown



Dark Grey



Black

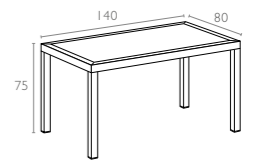

### 685 MAYA 80

HPL compact laminated tops 12 mm with the latest generation of air moulding thermoplastic legs. For indoor and outdoor use. Can be disassembled.

\* Dark colors not recommended in direct sunlight.

80x80 cm



White



Black

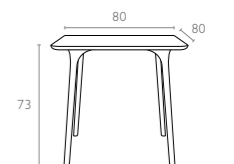

## 675 MAYA 120

HPL compact laminated tops  
12 mm with the latest generation  
of air moulding thermoplastic legs.  
For indoor and outdoor use.  
Can be disassembled.

*\* Dark colors not recommended in direct sunlight.*

Ø 120 cm



White



Black



## 690 MAYA 140

HPL compact laminated tops  
12 mm with the latest generation  
of air moulding thermoplastic legs.  
For indoor and outdoor use.  
Can be disassembled.

*\* Dark colors not recommended in direct sunlight.*

80x140 cm



White



Black

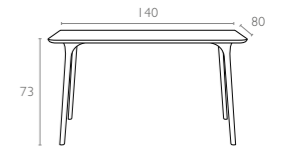

## 500 - 510 - 520 ICE

Table with clear transparent  
polycarbonate leg and painted  
aluminium base. Werzalit tops,  
resistant to outdoor use, available  
in white, black and silver grey.  
For indoor and outdoor use.

Code 500    Ø 60 cm  
Code 510    Ø 70 cm  
Code 520    Ø 80 cm



White



Black



Silver Grey

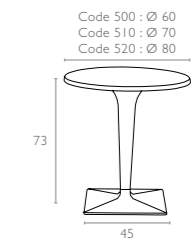

## 550 - 560 ICE

Table with clear transparent  
polycarbonate leg and painted  
aluminium base. Werzalit tops,  
resistant to outdoor use, available  
in white, black and silver grey.  
For indoor and outdoor use.

Code 550    60x60 cm  
Code 560    70x70 cm



White



Black



Silver Grey

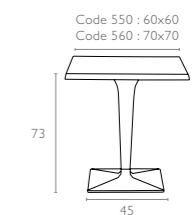

## 310 ICE Leg & Base

Clear transparent polycarbonate leg and painted aluminium base. For indoor and outdoor use.



Clear  
Transparent

Made with  
**Makrolon®**  
The high-tech polycarbonate

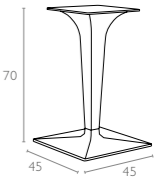

## 800 MANGO

Stacking table with the latest generation of air moulding thermoplastic injection. For indoor and outdoor use.

72x72 cm



White



Beige



Orange



Silver Grey

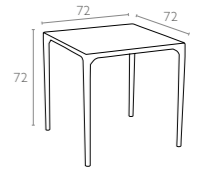

## 758 MANGO ALU

Stacking table with the latest generation of air moulding thermoplastic injection with legs in anodized aluminium. For indoor and outdoor use.

72x72 cm



White



Beige



Orange



Silver Grey

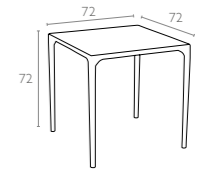

## 770 FORZA

Folding table with legs in anodized aluminium. Diameter 30 mm. Table top in recyclable polypropylene. For indoor and outdoor use.

80x80 cm



White



Beige



Orange



Red



Light Green



Black



Silver Grey



Teak

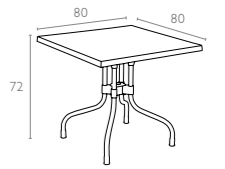

## 750 SORTIE

Table top in recyclable polypropylene, anodized aluminium legs. Diameter 25 mm. For indoor and outdoor use. Can be disassembled.

70x70 cm



White



Beige



Orange



Red



Light Green



Black

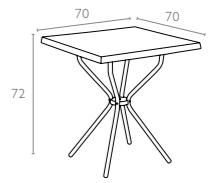

## 720 POPPY 80

Table top in recyclable polypropylene, anodized aluminium legs. Diameter 25 mm. For indoor and outdoor use. Can be disassembled.

Ø 80 cm



White



Beige



Orange



Red



Light Green



Black

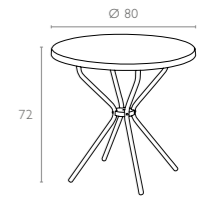

## 710 ELFO 70

Table top in recyclable polypropylene, anodized aluminium legs. Diameter 25 mm. For indoor and outdoor use. Can be disassembled.

Ø 70 cm



White



Beige



Orange



Red



Light Green



Black

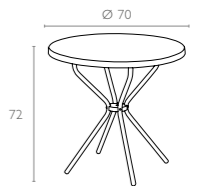

## 415 DODO

Suspension lamp in polycarbonate with 25W energy saving lamp. The diffuser can be removed without dismantling the electrical body, for an easy fitting and removal.



Clear  
Transparent



Black  
Transparent



Violet  
Transparent



Amber  
Transparent



Pink  
Transparent



Blue  
Transparent



Red  
Transparent



Glossy  
White

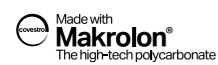
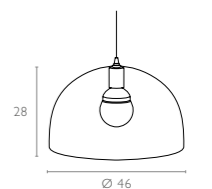

## 410 NOVA

Suspension lamp in polycarbonate with 25W energy saving lamp. The diffuser can be removed without dismantling the electrical body, for an easy fitting and removal.



Made with  
**Makrolon®**  
The high-tech polycarbonate



Clear  
Transparent



Black  
Transparent



Violet  
Transparent



Amber  
Transparent



Pink  
Transparent



Blue  
Transparent



Red  
Transparent



Glossy  
White

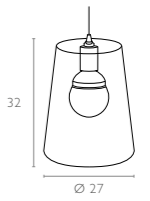

## 420 SMART

Table lamp made of transparent or coloured injected polycarbonate, with 40W lamp. Perfect gift idea.



Made with  
**Makrolon®**  
The high-tech polycarbonate



Clear  
Transparent



Black  
Transparent



Violet  
Transparent



Amber  
Transparent



Pink  
Transparent



Blue  
Transparent



Red  
Transparent



Glossy  
White

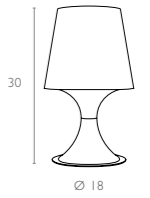

## INFORMATION

Technical dates and pictures in this catalogue are indicative and may not be considered binding; Siesta reserves the right to modify without notice for technical or commercial reasons the products in this catalogue. It is forbidden to re-produce the project or to re-print the catalogue.

All dimensions are in **cm**.

SYMBOLS KEY  
Ø = Diameter  
H = Height

Siesta App available on the App store



Art Direction & Graphic Art  
[www.adkreatik.com](http://www.adkreatik.com)



# Siesta exclusive

[www.siesta.com.tr](http://www.siesta.com.tr)



/SiestaFurniture



İŞILPLAST PLASTİK SANAYİ VE TİCARET A.Ş.  
Ulus Mah. Çatalca Yolu Cad. No:597 Tepecik 34537  
Büyükkçekmece - İSTANBUL / TURKEY  
Tel: +90 212 861 50 00  
Fax: +90 212 861 00 24  
[export@siesta.com.tr](mailto:export@siesta.com.tr)



OFFICIAL PARTNER

